

# EUR LED.LV

LED ENERGY-SAVING LIGHTING  
FOR HOME AND BUSINESS

## LED LIGHTING PRODUCTS CATALOGUE 2016-2017



# BRIEF INTRODUCTION

EUROLED.LV was established in 2009. We focus on professional LED lighting and offer high-quality, long-lasting and energy-efficient products, which complies with all norms and standards. Our experts provide professional consultation with individual approach for each client.

EUROLED.LV is an exclusive representative and holder of the rights to brand "VISIONAL" in Europe, USA and Russia. Since December 2014, we are an authorized dealer of "OSRAM" and Siteco products.



## LED products VISIONAL:

- the best quality without overpaying
- CE quality certificates, ROHS, as well as high-class energy-saving A ++
- energy saving up to 95%
- VISIONAL Premium has a factory warranty - 2-10 years
- made of environmentally friendly plastic, harmless for human health
- RA coefficient greater than 80
- proven reliability and durability

## Some of our clients:



LATVIJAS VALSTS MEŽI

Baltic Beach Hotel  
spa & resort



# OUR CUSTOMERS:



airBaltic



AMSERV



ECOLINES

ARMENIA

ATĒTIKA



AUTOTRANSPORTA DIREKCIJA

ap  
AUTO  
RINGS

autofavorīts



Baltvilla  
VIENĪCA HOTEL

BALTIC  
DATA



Balticovo

BALTIJAS TRANZĪTA SERVISS



Capital



AMBERWOOD  
CĒLKOKU GRĪDU RŪPNĪCA

DAILES TEĀTRIS  
SKAIDRIĀ, VIENKĀRSNĪĀ, KAISLĪĀ

darts



Domenikss

E-LATS

ARD  
EOLTAS



GROSauto



Latvijas Ebreju  
kopiena

i-Light.lv

LUX

Krūza  
BŪVMATERĪĻU VEIKALI

LARUS  
mēbeļu salons

KEKAVA



Latgranula

Latio

LATAKKO™  
WHEN THE CAR IS PASSION

Light24.net  
ONLINE LIGHTING STORE

LĪVAS GAISMA

CBF L-KO



Daintary

TITAN  
FITNESA KLUBS

Nissan Norde

MĒNESS APTIEKA

LTV  
LATVIJAS TELEVĪZIJA

RĪGA PLAZA

WÜRTH

RVR  
ANNO 1895

RD Electronics



# LED GLASS PANELS VISIONAL



## LED Glass panels VISIONAL

- Energy efficient – up to 80% energy savings
- Modern and stylish design
- Dimmable panels are available
- Instant light
- Non – Flickering
- Long life ranging
- Low heat emission
- Suitable for offices, shops, hotels and home

**5 YEARS  
FACTORY  
WARRANTY**

**VISIONAL<sup>®</sup> LED  
PREMIUM**



# LED GLASS PANELS VISIONAL



**VISIONAL LED PREMIUM**

**3 YEARS FACTORY WARRANTY**

**SAMSUNG LED**

**LED GLASS PANEL 6W**  
DEVELOPED IN EUROPE

CE ROHS COMPLIANT ENEC ErP

**EXTRA BRIGHT 600 LM**  
**CRI > 80**  
**120° BEAM ANGLE**  
**INSTANT FULL LIGHT**  
**LOW HEAT EMISSION**  
**IES FILE AVAILABLE**  
**NO FLICKERING**  
**50 000 HOURS EXTRA LONG LIFE**

SUITABLE FOR PROJECTS



## COLOR TEMPERATURE

3000K (WW)

4000K (NW)

6000K (CW)



## Easy to install and use!

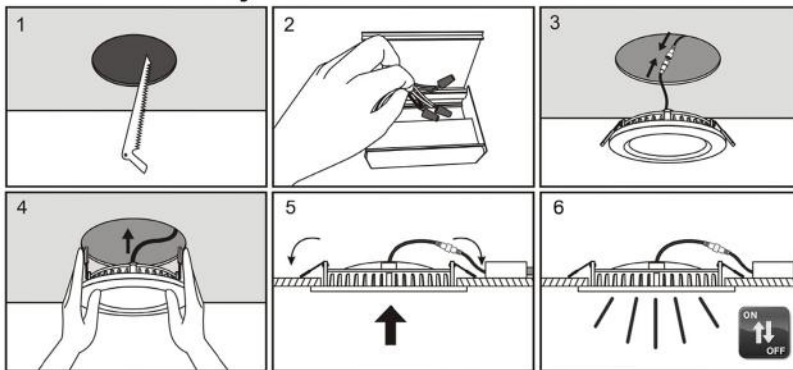

**IP44**

**120°**

**RA 80**



Model Modelis Модель	Power (Wattage) Jauda Мощность	LED type LED tips LED тип	Lumen output range Gaismas plūsmas Световой поток	Color temperature Krāsu temperatūra Температура цвета	Lifetime Kalpošanas ilgums Срок службы	Nominal voltage Spriegums Напряжение	Dimension Размеры Izmēri
LED Glass panel	6W	Samsung	600 Lm	3000K-6000K	50000 h.	165-265V	100x100 mm
LED Glass panel	12W	Samsung	1200 Lm	3000K-6000K	50000 h.	165-265V	160x160 mm
LED Glass panel	18W	Samsung	1800 Lm	3000K-6000K	50000 h.	165-265V	200x200 mm
LED Glass panel	27W	Samsung	2700 Lm	3000K-6000K	50000 h.	165-265V	260x65mm

**VISIONAL LED PREMIUM**



# LED SLIM PANELS VISIONAL



## LED Slim panels VISIONAL

- Energy efficient – up to 80% energy savings
- Slim, modern and stylish design
- Dimming option is available
- Instant light
- Non – Flickering
- Long life ranging
- Low heat emission
- Suitable for offices, shops, hotels and home

**5 YEARS  
FACTORY  
WARRANTY**



**VISIONAL<sup>®</sup> LED PREMIUM**



# LED SLIM PANELS VISIONAL



**LED SLIM PANEL**  
**SAMSUNG LED 12W**  
DEVELOPED IN EUROPE

CE ROHS COMPLIANT ENEC ErP 50 000 HOURS EXTRA LONG LIFE

**EXTRA BRIGHT**  
**1200 LM**

**CRI > 80**

**120°**  
BEAM ANGLE

**INSTANT FULL LIGHT**

**LOW HEAT EMISSION**

**IES FILE AVAILABLE**

**NO FLICKERING**

**50 000 HOURS EXTRA LONG LIFE**

**3 YEARS FACTORY WARRANTY**



**3W - 6W**



**3W - 6W**



**12W - 30W**



**12W - 30W**

## Quick and Easy Installation

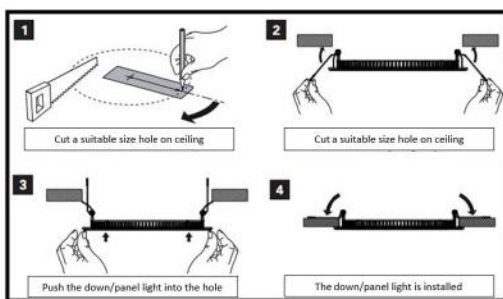
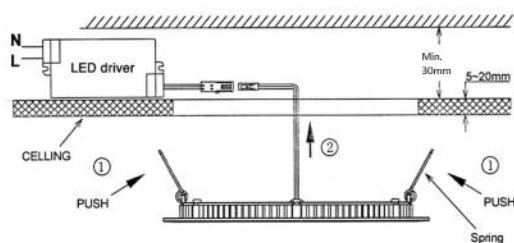

**IP44**

**120°**

**RA 80**



Model Modelis Модель	Power (Wattage) Jauda Мощность	LED type LED tips LED тип	Lumen output range Gaismas plūsma Световой поток	Color temperature Krāsu temperatūra Температура цвета	Lifetime Kalpošanas ilgums Срок службы	Nominal voltage Spriegums Напряжение	Dimension Размеры Izmēri
LED Slim panel	6W	Samsung	600 Lm	3000K-6000K	50000 h.	165-265V	85x85mm
LED Slim panel	12W	Samsung	1200 Lm	3000K-6000K	50000 h.	165-265V	120x120 mm
LED Slim panel	18W	Samsung	1800 Lm	3000K-6000K	50000 h.	165-265V	170x170 mm
LED Slim panel	27W	Samsung	2700 Lm	3000K-6000K	50000 h.	165-265V	225x225mm

# VISIONAL<sup>®</sup> LED PREMIUM



# LED PANELS VISIONAL

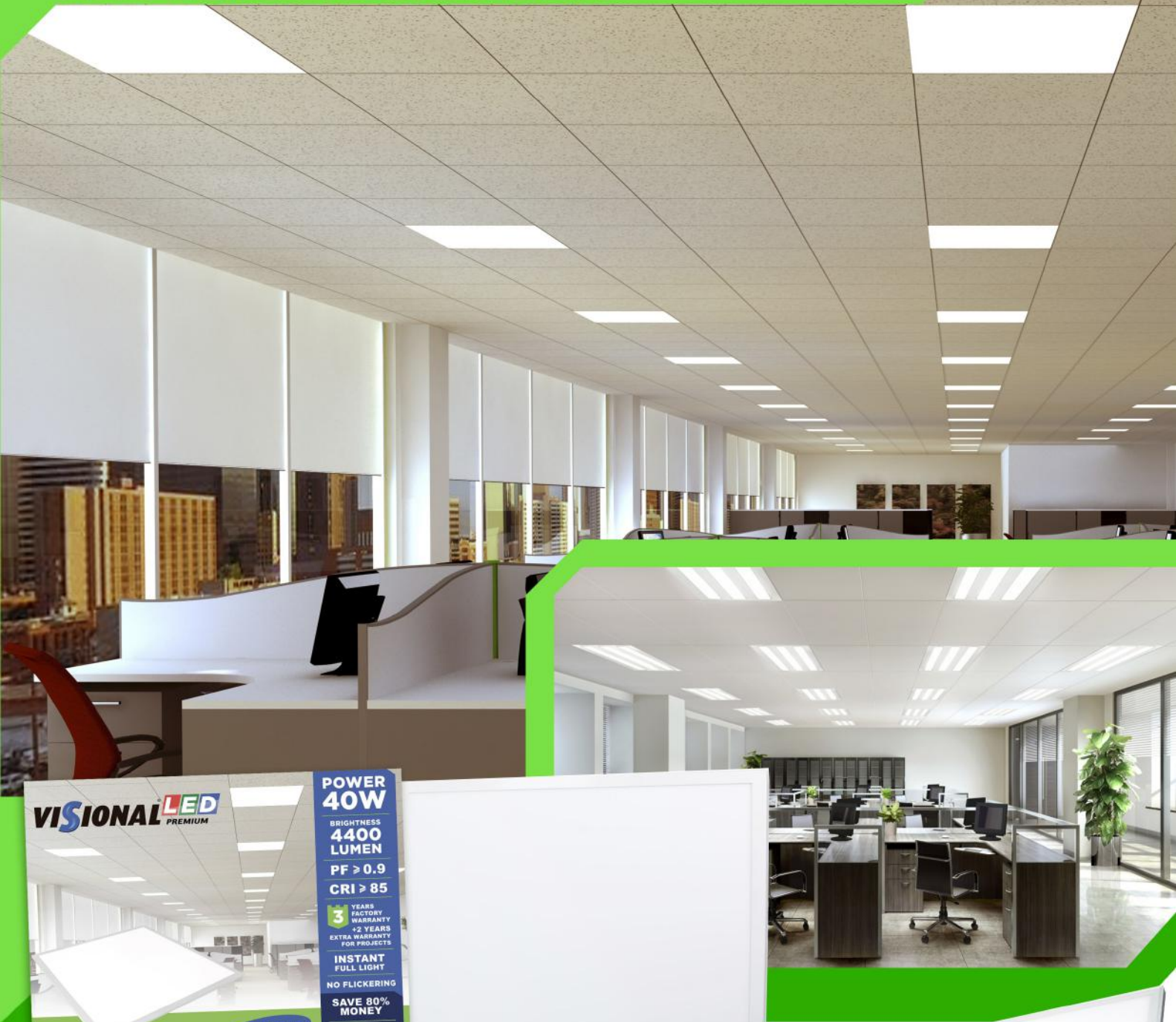

**VISIONAL LED PREMIUM**

**POWER 40W**

BRIGHTNESS  
**4400 LUMEN**

PF  $\geq$  0.9

CRI  $\geq$  85

**3 YEARS FACTORY WARRANTY**  
+2 YEARS EXTRA WARRANTY FOR PROJECTS

INSTANT FULL LIGHT

NO FLICKERING

SAVE 80% MONEY

50 000 HOURS EXTRA LONG LIFETIME

EXTRA CLEAR GLASS

120° BEAM ANGLE

IES FILE IS AVAILABLE

**SAMSUNG LED**

595x595x10mm  
DRIVER IS IN SET

MADE IN EUROPE

**LED PANEL LIGHT**

3000K WARM WHITE    4000K NATURAL WHITE    6000K COLD WHITE

CE   RoHS   TÜV   CB   FC   CCC   SAA

## LED panels VISIONAL

- Energy efficient – up to 80% energy savings
- Slim, modern and stylish design
- Non – Flickering
- Dimming feature is available
- Long life ranging
- High quality materials
- Low heat emission
- Brighter than most of the known brands

**5 YEARS FACTORY WARRANTY**

**VISIONAL LED PREMIUM**



# LED PANELS VISIONAL



## Installation methods

1

2

3

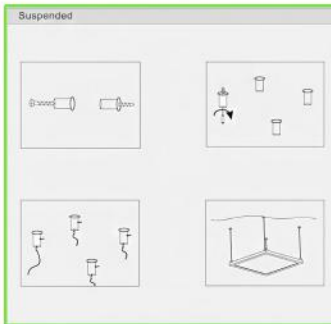
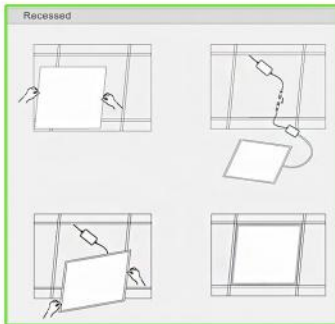
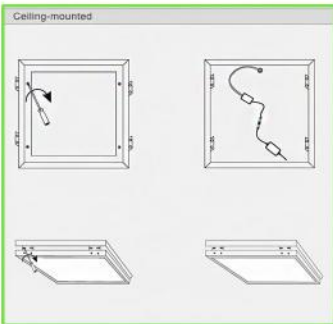

RA 80

50-60 Hz

IP44



IES files



Power (Wattage) Jauda Мощность	LED type LED tips LED тип	Lumen output range Gaismas plusma Световой поток	Color temperature Krāsu temperatūra Температура цвета	Beam angle Spīdēšanas leņķis Угол рассеивания	Lifetime Kalpošanas ilgums Срок службы	Nominal voltage (with power supply unit) Spriegums Напряжение	Dimension Размеры Izmēri
40W	Epistar	3200 Lm	3000-4000 K	120°	30000 h	200-240V AC	600x600 mm
36W (3 lines)	Samsung	3600 Lm	3000-6000 K	120°	50000 h	200-240V AC	600x600 mm
36W (3 lines)	Samsung	3600 Lm	3000-6000 K	120°	50000 h	200-240V AC	300x1200 mm
40W	Samsung	4000 Lm	3000-6000 K	120°	50000 h	200-240V AC	600x600 mm
40W	Samsung	4000 Lm	3000-6000 K	120°	50000 h	200-240V AC	600x1200 mm
45W	Epistar	3600 Lm	3000-6000 K	120°	30000 h	200-240V AC	600x600 mm
45W	Samsung	3600 Lm	3000-6000 K	120°	30000 h	200-240V AC	300x1200 mm
72W	Samsung	7200 Lm	3000-6000 K	120°	50000 h	200-240V AC	600x1200 mm
72W (3 lines)	Samsung	7200 Lm	3000-6000 K	120°	50000 h	200-240V AC	600x1200 mm

# VISIONAL<sup>®</sup> LED PREMIUM



# LED BULBS T8 / G13

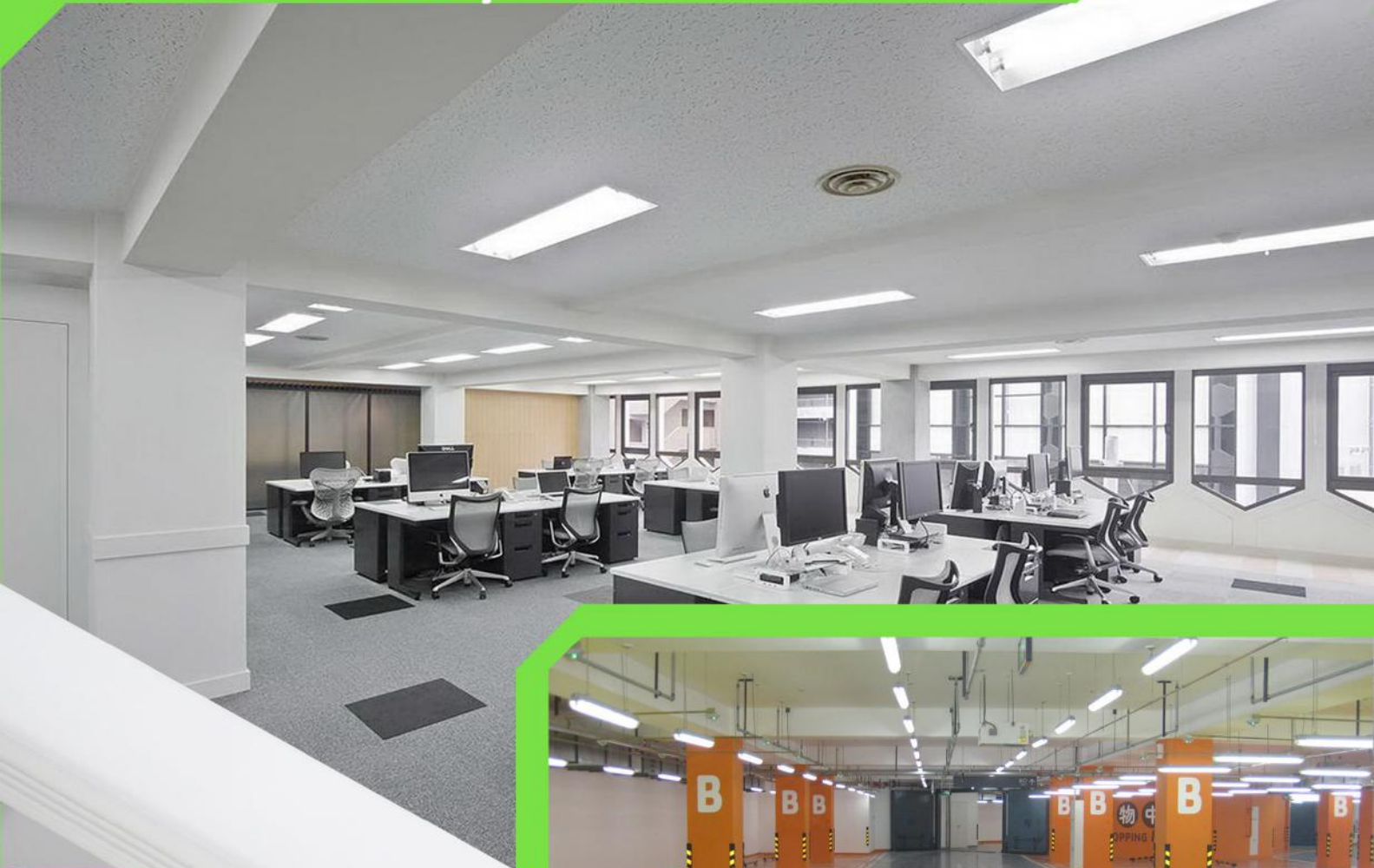

## LED T8 BULBS:

- Quick, simple and safe replacement
- Energy savings of up to 60 %
- Long life ranging
- High quality materials
- Proven reliability and durability
- Instant-on light
- Very high resistance to switching loads
- Also suitable for operation at low temperatures



**VISIONAL** **LED**  
PREMIUM



# LED BULBS T8 OSRAM / VISIONAL



## OSRAM SubstiTUBE Pure:

Ideal for simple lighting tasks

- Up to 86 lm/W
- For use in warehouses, underground garages and corridors
- Guarantee 2 years



## OSRAM SubstiTUBE Value:

Suitable for cost-oriented lighting tasks

- Up to 100 lm/W
- For use in private households, stairways, garages and cellar rooms
- Guarantee 3 years

## OSRAM SubstiTUBE Advanced:

High luminous intensity for sophisticated lighting tasks

- Up to 157 lm/W
- For use in production locations (also with extreme ambient temperatures between -20 °C and +50 °C) or sales spaces
- Guarantee 5 years

## OSRAM SubstiTUBE® Value



## OSRAM SubstiTUBE® Pure



## OSRAM SubstiTUBE® Advanced

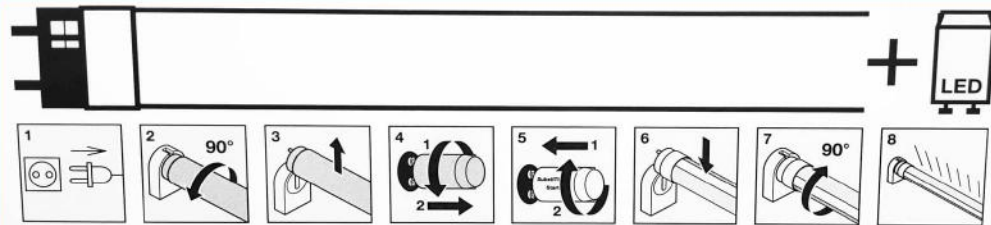

## VISIONAL LED





# LIGHTING FIXTURE FOR LED T8



## Waterproof lighting fixture for T8:

- Low energy consumption, up to 80% energy saving
- Good for schools, hospitals, parkings
- Easy to install
- Extra transparent glass
- High quality materials
- Instant full light
- Low heat emission
- Long lifetime
- Maximum efficiency



**VISIONAL** **LED**<sup>®</sup>  
PREMIUM



# LIGHTING FIXTURES FOR LED T8



Suspension kit also available



150 cm

x2 LED T8 / G13  
TUBES 1500mm

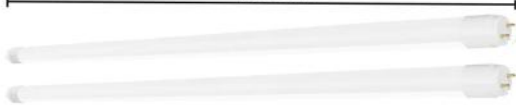

Easy suspendable  
Different application methods

Stainless steel



IP Level	IP65
Product material	Plastic /metal
Clips	Stainless steel
LED Bulbs T8(G13)	2 / 1 bulbs
Ballast	No



## Applications

- Schools, hospitals
- Indoor workplaces
- Parking garages
- Shopping center
- Industry, factories

## Advantages

- Metal clips
- Easy to install
- +10% brightness
- Transparent glass
- High quality materials



120 cm



150 cm



120 cm



# VISIONAL<sup>®</sup> LED PREMIUM



# LED LINEAR LIGHTS VISIONAL



## LED LINEAR LIGHTS:

- Quick and simple to install
- Energy savings of up to 60 %
- Long life ranging
- Dimming feature is available
- Proven reliability and durability
- Instant-on light
- Very high resistance to switching loads
- Also suitable for operation at low temperatures



**VISIONAL** **LED**  
PREMIUM



# LED LINEAR LIGHTS VISIONAL

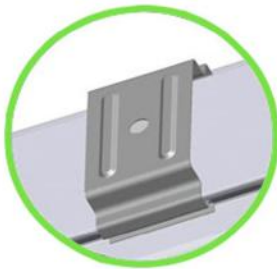

up to  
**5**  
YEARS  
FACTORY  
WARRANTY



30cm -  
10W



60cm -  
20W



150cm  
-60W



150cm  
-60W



RA 80

50-60  
Hz

IP44



Power (Wattage) Jauda Мощность	LED type LED tips LED тип	Lumen output range Gaismas plusma Световой поток	Color temperature Krāsu temperatūra Температура цвета	Beam angle Spīdēšanas leņķis Угол рассеивания	Lifetime Kalpošanas ilgums Срок службы	Nominal voltage Spriegums Напряжение	Length Izmēri Размеры
10W	Samsung	1000 Lm	3000K-6000K	120°	40000 h	200-240V AC	300 mm
20W	Samsung	2000 Lm	3000K-6000K	120°	40000 h	200-240V AC	600 mm
40W	Samsung	4000 Lm	3000K-6000K	120°	40000 h	200-240V AC	1200 mm
60W	Samsung	6000 Lm	3000K-6000K	120°	40000 h	200-240V AC	1500 mm

**VISIONAL** <sup>®</sup> **LED**  
PREMIUM



# LED TRACK LIGHTS VISIONAL

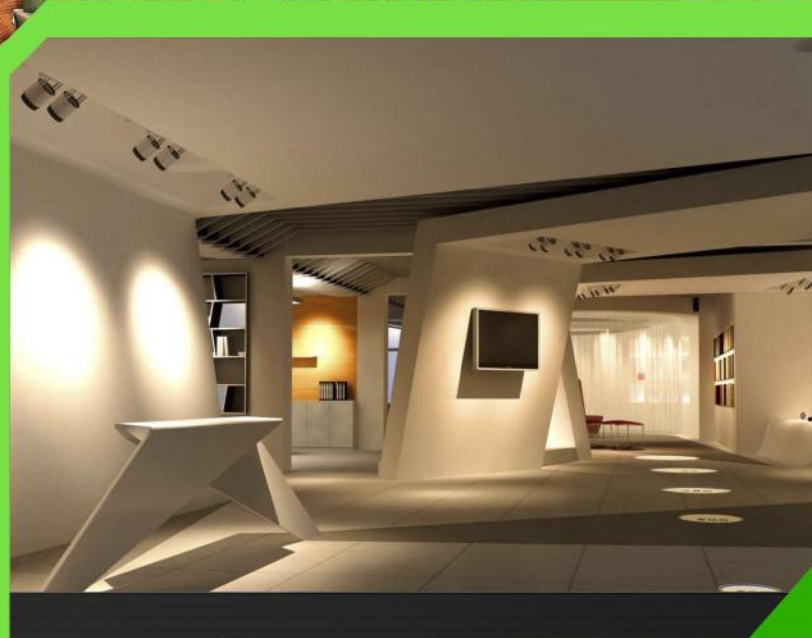

## LED Track Lights VISIONAL:

- Simple and fast connection
- Modern and stylish design
- Create a unique lighting design
- Energy efficient – up to 60% energy savings
- Instant light
- Option of dimmable LED
- High quality materials
- Suitable for shop windows, shelves, salerooms, museums, art shops etc.

**5 YEARS  
FACTORY  
WARRANTY**



**BRIDGELUX**  
The Magic of Light™

**CITIZEN**  
Micro HumanTech

**VISIONAL** **LED**  
PREMIUM



# LED TRACK LIGHTS VISIONAL

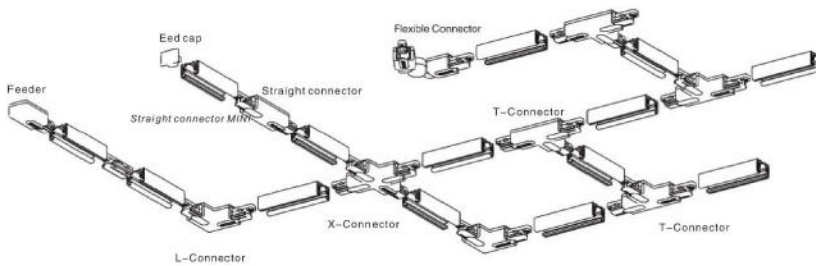

50-60 Hz

IP44



RA>90

IES files



Power (Wattage) Jauda Мощность	LED type LED tips LED тип	Lumen output range Gaismas plūsma Световой поток	Color temperature Krāsu temperatūra Температура цвета	Lifetime Kalpošanas ilgums Срок службы	Nominal voltage Spriegums Напряжение	Operating temperature range Рабочий диапазон температур Darba temperatūras diapazons	Dimension Размеры Izmēri
12W	Bridgelux	1020 lm	2500K-7000K	24°/ 30°/ 36°/ 45°/ 60°	white/ black/ silver	200-240V AC	50000 h.
15W	Bridgelux	1275 lm	2500K-7000K	24°/ 30°/ 36°/ 45°/ 60°	white/ black/ silver	200-240V AC	50000 h.
20W	Bridgelux	1700 lm	2500K-7000K	24°/ 30°/ 36°/ 45°/ 60°	white/ black/ silver	200-240V AC	50000 h.
25W	CITIZEN	2500 lm	2500K-7000K	24°/ 30°/ 36°/ 45°/ 60°	white/ black/ silver	200-240V AC	50000 h.
30W	CITIZEN	3000 lm	2500K-7000K	24°/ 30°/ 36°/ 45°/ 60°	white/ black/ silver	200-240V AC	50000 h.
35W	CITIZEN	3500 lm	2500K-7000K	24°/ 30°/ 36°/ 45°/ 60°	white/ black/ silver	200-240V AC	50000 h.
45W	CITIZEN	4500 lm	2500K-7000K	24°/ 30°/ 36°/ 45°/ 60°	white/ black/ silver	200-240V AC	50000 h.
60W	CITIZEN	6000 lm	2500K-7000K	24°/ 30°/ 36°/ 45°/ 60°	white/ black/ silver	200-240V AC	50000 h.
65W	CITIZEN	6500 lm	2500K-7000K	24°/ 30°/ 36°/ 45°/ 60°	white/ black/ silver	200-240V AC	50000 h.

# VISIONAL<sup>®</sup> LED PREMIUM



# LED HIGH BAY LIGHT UFO



izoterm



## LED High Bay UFO

- Proven reliability and durability
- Energy efficient – up to 80% energy savings
- Improved safety, colour quality
- Instant light, dimming feature available
- Improved temperature rating
- Highly efficient high bay luminaire for ceiling heights from 6 to 12 m
- Suitable for industry, warehouses, logistic centers and traffic areas
- Dimming feature is available

**7** YEARS  
FACTORY  
WARRANTY



**VISIONAL** **LED**  
PREMIUM



# LED HIGH BAY LIGHT UFO



80W - 200W



80W - 200W



145W - 230W

**OSRAM**

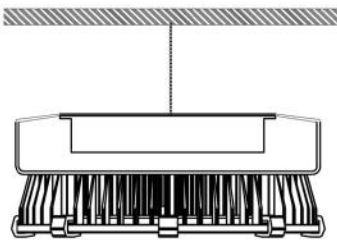
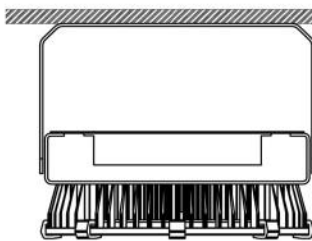

IP65 protection grade

Wall mounted installation

Suspended

RA 80



IP65



IES files



Power (Wattage) Jauda Мощность	LED type LED tips LED тип	Lumen output range Gaismas plasma Световой поток	Color temperature Krāsu temperatura Температура цвета	Beam angle Spīdēšanas leņķis Угол рассеивания	Lifetime Kalpošanas ilgums Срок службы	Nominal voltage Spriegums Напряжение	Power supply unit Блок питания Barošanas bloks
60W	PHILIPS / OSRAM / NICHIA	6600 lm	2800K-7000K	90° - 120°	50000 h.	85-265V	Philips / Mean Well
80W	PHILIPS / OSRAM / NICHIA	8800 lm	2800K-7000K	90° - 120°	50000 h.	85-265V	Philips / Mean Well
100W	PHILIPS / OSRAM / NICHIA	11000 lm	2800K-7000K	90° - 120°	50000 h.	85-265V	Philips / Mean Well
120W	PHILIPS / OSRAM / NICHIA	13200 lm	2800K-7000K	90° - 120°	50000 h.	85-265V	Philips / Mean Well
150W	PHILIPS / OSRAM / NICHIA	16500 lm	2800K-7000K	90° - 120°	50000 h.	85-265V	Philips / Mean Well
200W	PHILIPS / OSRAM / NICHIA	22000 lm	2800K-7000K	90° - 120°	50000 h.	85-265V	Philips / Mean Well
145W	OSRAM	13200 lm	4000K	120°	50000 h.	220-240 V	OSRAM
230W	OSRAM	21200 lm	4000K	120°	50000 h.	220-240 V	OSRAM



60W - 200W

**PHILIPS**  
**NICHIA**

**MW**  
**MEAN WELL**

**VISIONAL LED**  
**PREMIUM**



# LED HIGH BAY LIGHTS

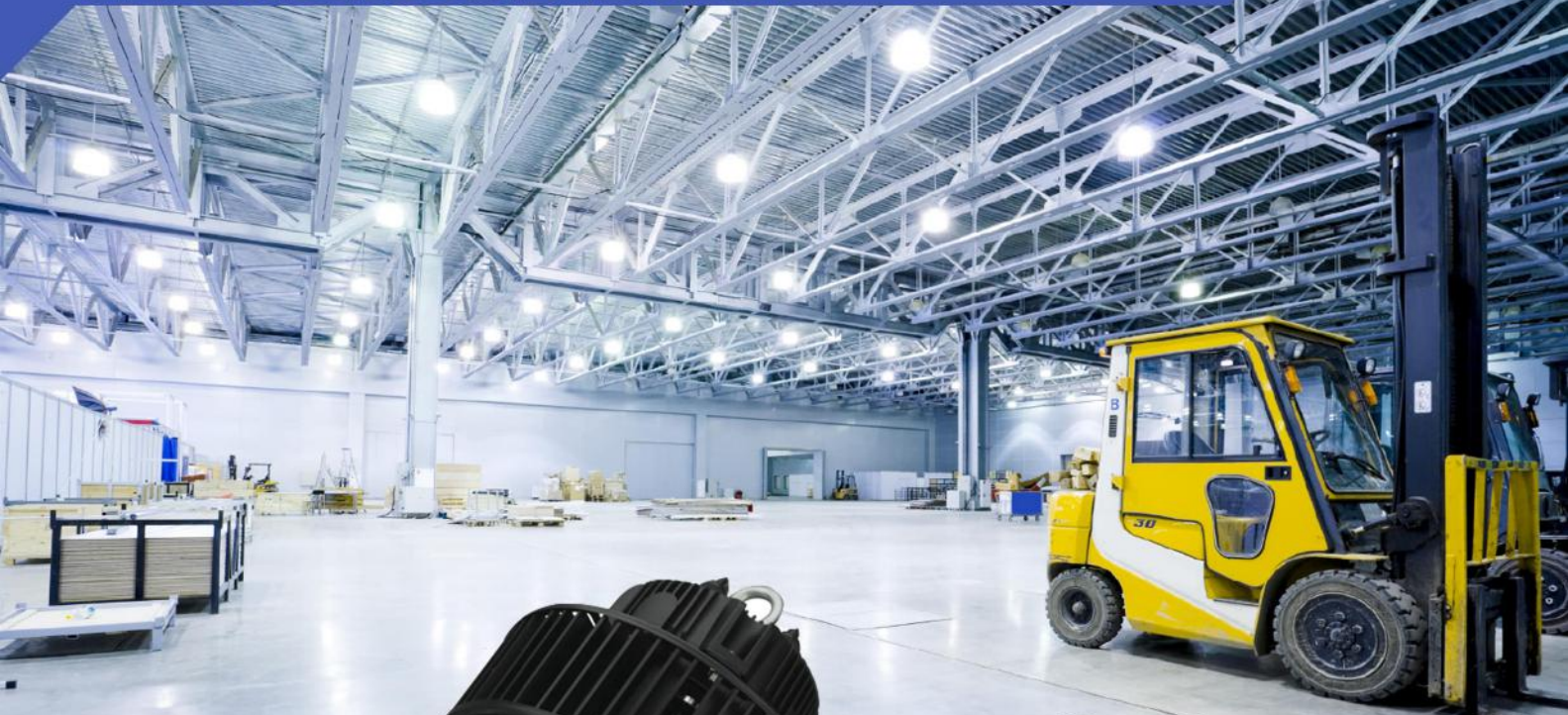

## LED High Bay Lights:

- High output – High efficiency
- Energy efficient – up to 80% energy savings
- Proven reliability and durability
- Range of illumination angles or different mounting height
- Instant on/off operation
- Dimming option is available
- Improved temperature rating and safety
- Suitable for industry, warehouses, logistic centers etc.
- Long-term use - up to 20 years

**7 YEARS  
FACTORY  
WARRANTY**



**VISIONAL<sup>®</sup> LED  
PREMIUM**



# LED HIGH BAY LIGHTS

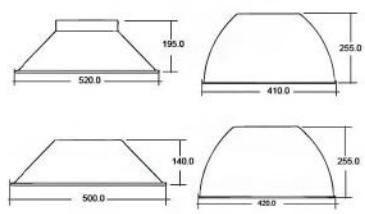
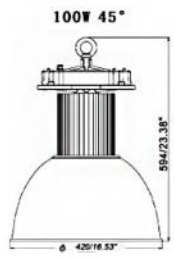

Beam angle 45° / 90° / 120°

- 50-60 Hz
- IP65
- 
- RA 80
- IES files
- CE
- RoHS
- TUV

Power (Wattage) Jauda Мощность	LED type LED tips LED тип	Lumen output range Gaismas plūsma Световой поток	Color temperature Krāsu temperatūra Температура цвета	Beam angle Spīdēšanas leņķis Угол рассеивания	Lifetime Kalpošanas ilgums Срок службы	Nominal voltage Spriegums Напряжение	Power supply unit Блок питания Вароšanas bloks
30W	Philips / Osram	3300 lm	3000K-6000K	40° - 120°	50000 h.	85-265V	Philips / Mean Well
50W	Philips / Osram	5500 lm	3000K-6000K	40° - 120°	50000 h.	85-265V	Philips / Mean Well
80W	Philips / Osram	8800 lm	3000K-6000K	40° - 120°	50000 h.	85-265V	Philips / Mean Well
100W	Philips / Osram	11000 lm	3000K-6000K	40° - 120°	50000 h.	85-265V	Philips / Mean Well
120W	Philips / Osram	13200 lm	3000K-6000K	40° - 120°	50000 h.	85-265V	Philips / Mean Well
150W	Philips / Osram	16500 lm	3000K-6000K	40° - 120°	50000 h.	85-265V	Philips / Mean Well
200W	Philips / Osram	22000 lm	3000K-6000K	40° - 120°	50000 h.	85-265V	Philips / Mean Well
250W	Philips / Osram	27500 lm	3000K-6000K	40° - 120°	50000 h.	85-265V	Philips / Mean Well
300W	Philips / Osram	33000 lm	3000K-6000K	40° - 120°	50000 h.	85-265V	Philips / Mean Well



# LED STREET LIGHTS



## City lighting the benefits of using LED:

- Ideal replacement for traditional lights
- Energy saving **up to 5 times**
- City streets look modern and trendy
- Long-term use - **up to 20 years**
- Reduction of car accidents because of low-light
- Choice of lighting colors (warm white, white, cool white)
- Dimmable opportunity - an opportunity to install on existing network
- Product warranty **from 3 to 10 years**

**VISIONAL** **LED**  
PREMIUM



# LED STREET LIGHTS

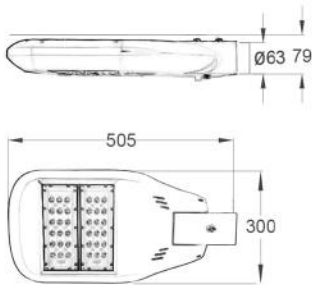

20W - 60W



80W - 100W



120W - 150W



180W - 200W

45°-120° 50-60 Hz IP67 RA 80 IES files

Power (Wattage) Jauda Мощность	LED type LED tips LED тип	Lumen output range Gaismas plūsmas Световой поток	Color temperature Krāsu temperatūra Температура цвета	Lifetime Kalpošanas ilgums Срок службы	Nominal voltage Spriegums Напряжение	Operating temperature range Раб. diapazons темпл. Darba temp. diapazons	Dimension Размеры Izmēri
20W	Samsung / CREE / LG	2200 / 2700 lm	2700K-7000K	50000 / 100000 h.	90 ~ 305V	-30°C ~ +60°	392x305x75mm
30W	Samsung / CREE / LG	3300 / 4050 lm	2700K-7000K	50000 / 100000 h.	90 ~ 305V	-30°C ~ +60°	392x305x75mm
40W	Samsung / CREE / LG	4400 / 5400 lm	2700K-7000K	50000 / 100000 h.	90 ~ 305V	-30°C ~ +60°	392x305x75mm
50W	Samsung / CREE / LG	5500 / 6750 lm	2700K-7000K	50000 / 100000 h.	90 ~ 305V	-30°C ~ +60°	392x305x75mm
60W	Samsung / CREE / LG	6600 / 8100 lm	2700K-7000K	50000 / 100000 h.	90 ~ 305V	-30°C ~ +60°	392x305x75mm
80W	Samsung / CREE / LG	8800 / 10800 lm	2700K-7000K	50000 / 100000 h.	90 ~ 305V	-30°C ~ +60°	472x305x75mm
100W	Samsung / CREE / LG	11000 / 13500 lm	2700K-7000K	50000 / 100000 h.	90 ~ 305V	-30°C ~ +60°	472x305x75mm
120W	Samsung / CREE / LG	13200 / 16200 lm	2700K-7000K	50000 / 100000 h.	90 ~ 305V	-30°C ~ +60°	552x305x75mm
150W	Samsung / CREE / LG	16500 / 20250 lm	2700K-7000K	50000 / 100000 h.	90 ~ 305V	-30°C ~ +60°	552x305x75mm
200W	Samsung / CREE / LG	22000 / 27000 lm	2700K-7000K	50000 / 100000 h.	90 ~ 305V	-30°C ~ +60°	712x305x75mm
250W	Samsung / CREE / LG	25000 / 33750 lm	2700K-7000K	50000 / 100000 h.	90 ~ 305V	-30°C ~ +60°	792x305x75mm
300W	Samsung / CREE / LG	33000 / 40500 lm	2700K-7000K	50000 / 100000 h.	90 ~ 305V	-30°C ~ +60°	792x305x75mm





# LED FLOOD LIGHTS VISIONAL



## LED flood lights VISIONAL:

- Energy efficient – up to 80% energy savings
- Proven reliability and durability
- Low heat emission
- Instant start-up for added security
- High quality materials
- IP65 weather resistant
- Maintenance cost reduction



**5 YEARS  
FACTORY  
WARRANTY**

**VISIONAL** **LED**  
PREMIUM



# LED FLOOD LIGHTS VISIONAL



10W - 50W



10W - 250W



10W-100W



100W - 200W



50-60 Hz

IP65



RA 80

IES files



Power (Wattage) Jauda Мощность	LED type LED tips LED тип	Lumen output range Gaismas plusma Световой поток	Color temperature Krāsu temperatūra Температура цвета	Beam angle Spīdēšanas leņķis Угол рассеивания	Lifetime Kalpošanas ilgums Срок службы	Nominal voltage Spriegums Напряжение	Operating temperature range Рабочий диапазон температур Darba temperatūras diapazons
10W	Samsung	1000 lm	3000K-6000K	150°	50000 h.	85-265V	-30°C ~ +50°
20W	Samsung	2000 lm	3000K-6000K	150°	50000 h.	85-265V	-30°C ~ +50°
30W	Samsung	3000 lm	3000K-6000K	150°	50000 h.	85-265V	-30°C ~ +50°
50W	Samsung	5000 lm	3000K-6000K	150°	50000 h.	85-265V	-30°C ~ +50°
100W	Samsung	10000 lm	3000K-6000K	150°	50000 h.	85-265V	-30°C ~ +50°
100W (lens)	Bridgelux	11000 lm	3000K-6000K	90°	50000 h.	85-265V	-30°C ~ +50°
150W (lens)	Bridgelux	16000 lm	3000K-6000K	90°	50000 h.	85-265V	-30°C ~ +50°
200W (lens)	Bridgelux	21000 lm	3000K-6000K	90°	50000 h.	85-265V	-30°C ~ +50°
10W	Bridgelux	1050 lm	3000K-6000K	150°	50000 h.	85-265V	-30°C ~ +50°
20W	Bridgelux	2100 lm	3000K-6000K	150°	50000 h.	85-265V	-30°C ~ +50°
30W	Bridgelux	3150 lm	3000K-6000K	150°	50000 h.	85-265V	-30°C ~ +50°
50W	Bridgelux	5250 lm	3000K-6000K	150°	50000 h.	85-265V	-30°C ~ +50°
100W	Bridgelux	10500 lm	3000K-6000K	150°	50000 h.	85-265V	-30°C ~ +50°
250W	Bridgelux	26250 lm	3000K-6000K	150°	50000 h.	85-265V	-30°C ~ +50°

# VISIONAL<sup>®</sup> LED PREMIUM



# LED FLOOD LIGHTS VISIONAL IP66

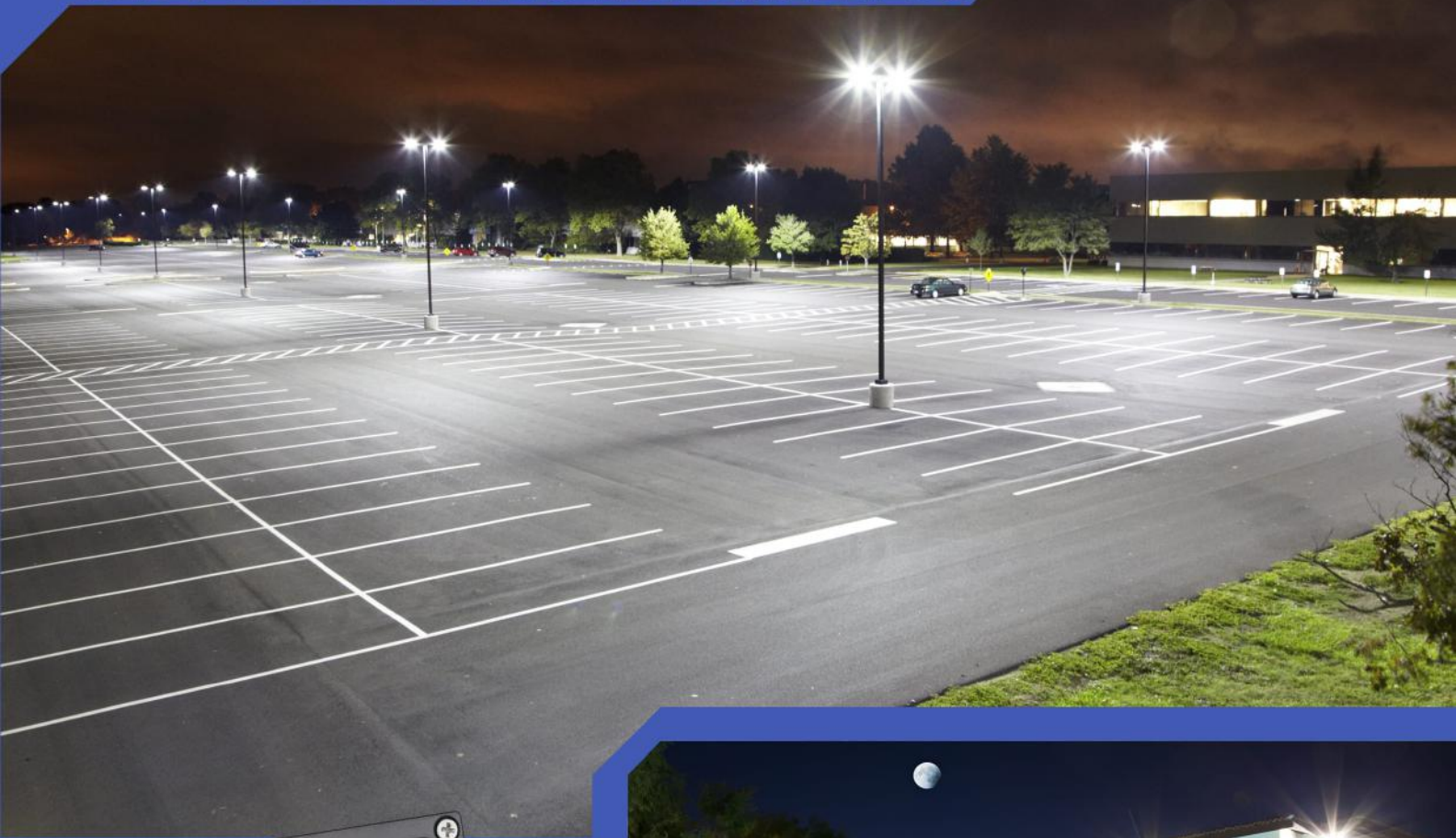

## LED Flood Lights IP66:

- Energy efficient – up to 70% energy savings
- Instant-on light
- IP66 weather resistant
- Good color rendering
- PIR version available
- Long life ranging
- High quality materials
- Proven reliability and durability



**3 YEARS  
FACTORY  
WARRANTY**

**VISIONAL<sup>®</sup> LED**  
**PREMIUM**



# LED FLOOD LIGHTS VISIONAL IP66



IP66 RA 80 50-60 Hz

Model Modelis Модель	Power (Wattage) Jauda Мощность	LED type LED tips LED тип	Lumen output range Gaismas plasma Световой поток	Color temperature Krāsu temperatura Температура цвета	Beam angle Spīdēšanas leņķis Угол рассеивания	Lifetime Kalpošanas ilgums Срок службы	Nominal voltage Spriegums Напряжение	Operating temperature range Рабочий диапазон температур Darba temperatūras diapazons
LED Flood Light	10W	Samsung	1050 lm	3000K-6000K	160°	50000 h.	85-265V	-30°C ~ +50°
LED Flood Light	20W	Samsung	2100 lm	3000K-6000K	160°	50000 h.	85-265V	-30°C ~ +50°
LED Flood Light	30W	Samsung	3150 lm	3000K-6000K	160°	50000 h.	85-265V	-30°C ~ +50°
LED Flood Light	50W	Samsung	5250 lm	3000K-6000K	160°	50000 h.	85-265V	-30°C ~ +50°
LED Flood Light PIR	10W	Samsung	1050 lm	3000K-6000K	160°	50000 h.	85-265V	-30°C ~ +50°
LED Flood Light PIR	20W	Samsung	2100 lm	3000K-6000K	160°	50000 h.	85-265V	-30°C ~ +50°
LED Flood Light PIR	30W	Samsung	3150 lm	3000K-6000K	160°	50000 h.	85-265V	-30°C ~ +50°
LED Flood Light PIR	50W	Samsung	5250 lm	3000K-6000K	160°	50000 h.	85-265V	-30°C ~ +50°
LED Flood Light RGB	10W	Samsung	~ 800 lm	RGB	160°	50000 h.	85-265V	-30°C ~ +50°
LED Flood Light RGB	20W	Samsung	~ 1600 lm	RGB	160°	50000 h.	85-265V	-30°C ~ +50°
LED Flood Light RGB	30W	Samsung	~ 2400 lm	RGB	160°	50000 h.	85-265V	-30°C ~ +50°
LED Flood Light RGB	50W	Samsung	~ 4000 lm	RGB	160°	50000 h.	85-265V	-30°C ~ +50°

Made in Latvia



# VISIONAL<sup>®</sup> LED PREMIUM



# LED FLOOD LIGHTS



## LED FLOOD LIGHTS:

- Up to 80% energy saving
- Stylish, compact design
- Instant start-up for added security
- Dimming feature is available
- Good color rendering
- Long life ranging, low heat emission
- High quality materials
- Proven reliability and durability

**5 YEARS  
FACTORY  
WARRANTY**

**VISIONAL<sup>®</sup> LED  
PREMIUM**



# LED FLOOD LIGHTS



10W - 50W



80W - 150W



10W - 50W



80W - 200W



Wall-mounted  
(Area Floodlight)

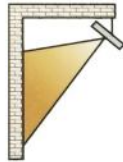

Canopy-mounted  
(Shops Facade Floodlight)



Arm-mounted  
(Signvue Uplight)



Arm-mounted  
(Signvue Downlight)



Wall-mounted  
(Tunnel lighting)



Pole-mounted  
(Parking lots)



Suspend-mounted  
(Baylight High / Low)



On the ground  
(Landscape lighting)

50-60  
Hz

IP65



RA 80

IES  
files



Power (Wattage) Jauda Мощность	LED type LED tips LED тип	Lumen output range Gaismas plasma Световой поток	Color temperature Krāsu temperatura Температура цвета	Beam angle Spīdēšanas leņķis Угол рассеивания	Lifetime Kalpošanas ilgums Срок службы	Nominal voltage Spriegums Напряжение	Operating temperature range Рабочий диапазон температур Darba temperatūras diapazons	Dimension Размеры Izmēri
10W	Philips 3030	1100 lm	3000K-6000K	120°	50000 h.	100-240V	-20°C ~ +40°C	110x130x50mm
20W	Philips 3030	2200 lm	3000K-6000K	120°	50000 h.	100-240V	-20°C ~ +40°C	156x175x57mm
30W	Philips 3030	3300 lm	3000K-6000K	120°	50000 h.	100-240V	-20°C ~ +40°C	171x192x59mm
50W	Philips 3030	5500 lm	3000K-6000K	120°	50000 h.	100-240V	-20°C ~ +40°C	200x235x66mm
80W	Philips 3030	8800 lm	3000K-6000K	120°	50000 h.	100-240V	-20°C ~ +40°C	250x285x70mm
100W	Philips 3030	11000 lm	3000K-6000K	120°	50000 h.	100-240V	-20°C ~ +40°C	300x365x92mm
120W	Philips 3030	13200 lm	3000K-6000K	120°	50000 h.	100-240V	-20°C ~ +40°C	300x365x92mm
200W	Philips 3030	22000 lm	3000K-6000K	120°	50000 h.	100-240V	-20°C ~ +40°C	300x365x92mm
10W	OSRAM 3030	1100 lm	3000K-6000K	120°	50000 h.	100-240V	-20°C ~ +40°C	130x110x50mm
20W	OSRAM 3030	2200 lm	3000K-6000K	120°	50000 h.	100-240V	-20°C ~ +40°C	175x156x57mm
30W	OSRAM 3030	3300 lm	3000K-6000K	120°	50000 h.	100-240V	-20°C ~ +40°C	192x171x59mm
50W	OSRAM 3030	5500 lm	3000K-6000K	120°	50000 h.	100-240V	-20°C ~ +40°C	235x200x66 mm
80W	OSRAM 3030	8800 lm	3000K-6000K	120°	50000 h.	100-240V	-20°C ~ +40°C	285x250x70mm
100W	OSRAM 3030	11000 lm	3000K-6000K	120°	50000 h.	100-240V	-20°C ~ +40°C	360x300x90mm
120W	OSRAM 3030	13200 lm	3000K-6000K	120°	50000 h.	100-240V	-20°C ~ +40°C	360x300x90mm
150W	OSRAM 3030	16500 lm	3000K-6000K	120°	50000 h.	100-240V	-20°C ~ +40°C	500x380x115mm

OSRAM  
PHILIPS

MW  
MEAN WELL

VISIONAL LED  
PREMIUM



# OSRAM LIGHTIFY PRODUCTS



## OSRAM LIGHTIFY products:

OSRAM is dedicated to light for over 100 years and one of the leading light manufacturers in the world.

Permanent progress, from conventional illumination, to LED technology up to grounds in terms of intelligent lighting illustrates that OSRAM strives to improve quality of light with optimal products and solutions with the state-of-the-art technology.

- Light can be so much more – our dynamic scenes offer for the first time preset light variations, which can be set for a specific lamp or even an entire group.
- LIGHTIFY can give you a better sense of security by simulating your presence at home, if you are on a business trip or even on vacation.
- You have the option to control your lights singly or in groups.

# OSRAM





# OSRAM LIGHTIFY PRODUCTS



*You can create completely new and exciting light effects with the flexible, self-bonding LED strip that can be steplessly set to all RGB colors, and that also contains white LED. Either concealed as indirect lighting or visible as direct lighting, as desired. Or integrate LIGHTIFY Flex into furniture. There are no limits to your creativity!*

*For great light accents and indirect lighting You can create completely new and exciting light effects with the flexible, self-bonding LED strip that can be steplessly set to all RGB colors, and that also contains white LED. Either concealed as indirect lighting or visible as direct lighting, as desired. Or integrate LIGHTIFY Flex into furniture. There are no limits to your creativity!*



*The center piece of the LIGHTIFY system is the Gateway, which connects to the local WIFI Router and at the same time, transfers the signal further to all products, that work with LIGHTIFY or are LIGHTIFY compatibel. OSRAM LIGHTIFY is a certified member of the ZigBee Alliance and hence uses the open standard for light control.*

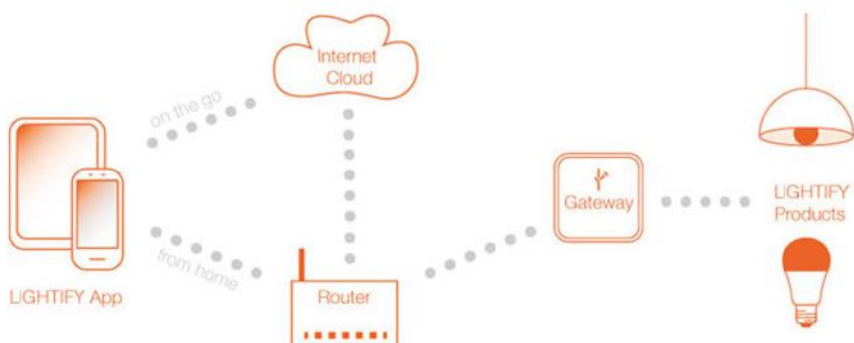

# OSRAM





# OSRAM NOXLITE PRODUCTS



## OSRAM LED products:

- Osram official dealer
- High quality and proven reliability
- Easy to install and use
- Pleasant homogenous light
- Long lifetime thanks to LED technology
- Low heat emission
- Osram warranty

# OSRAM





# OSRAM NOXLITE PRODUCTS



## NOXLITE CIRCULAR

*Timelessly elegant. And yet equipped with state-of-the-art technology.*

*Product benefits:*

*High quality of light – uniform, wide illumination with direct and indirect components*

*Pleasant light: Warm white, diffuse, glare-reduced light distribution*

*Concise attractive design during day and night*

*Saves up to 25 % energy*



**NOXLITE CIRCULAR**

## NOXLITE LED GARDEN SPOT

*It is an easy garden light and terrace wall washer with minimal power consumption*

*Product benefits:*

*Various application areas*

*Spots adjustable in any direction*

*Decorative illumination (RGB, White)*

*Various possibilities for garden, terrace and balcony use*



**NOXLITE LED GARDEN SPOT**

## NOXLITE SMART LED

*NOXLITE Smart revolutionizes outdoor lighting.*

*Product benefits:*

*Innovative, efficient solutions for planar light*

*Wireless grouping of several luminaires*

*Concealed motion and day/night sensor*

*Robust, UV-resistant housing protected against dust and water jets (IP55)*

*Simple mounting with the "Fast-Fix Connection"*



**NOXLITE SMART**

## NOXLITE LED HP FLOODLIGHT

*Optimal solution that highly supports the sense of security.*

*Product benefits:*

*Precise illumination*

*IP44 protection rating*

*Notifies any movement due to two PIR sensors (for sneak-by protection)*

*Simple installation - 'Fast Fix Connection'*

*Saves up to 80 % energy*



**NOXLITE LED HP FLOODLIGHT**

# OSRAM





# OSRAM LEDVANCE PRODUCTS



## OSRAM LEDVANCE products:

LEDVANCE lights up your future - new partner with a familiar heritage

Products at a glance:

- Brand new LEDVANCE LED trade luminaires
- Smart Home products
- Edition 1906: vintage lamps and luminaires
- Extensive LED lamp portfolio with innovative new products
- Traditional lamps for general lighting
- High quality and proven reliability

# LEDVANCE

## OSRAM





# OSRAM LEDVANCE PRODUCTS



## LEDVANCE PANEL LED

Luminaire efficacy: up to 110 lm/W

Luminous flux: up to 4,000 lm

Type of protection: IP20

Aluminum housing, polystyrene diffuser

Lifetime (L70/B50): up to 50,000 h

Certificates: CE, CB, TUEV SUED

Available with beam angle: 120°, 90°

Available with color temperature: 3,000 K, 4,000 K, 6,500 K



## LEDVANCE SURFACE CIRCULAR LED

Luminaire efficacy: up to 80 lm/W

Luminous flux: up to 1,920 lm

Color temperature: 3,000 K, 4,000 K

Beam angle: 120°

Type of protection: IP44

Impact resistance: IK03

Lifetime (L70/B50): up to 30,000 h

Versions with movement and daylight sensor available (microwave sensor)



LEDVANCE PANEL LED



LEDVANCE SURFACE CIRCULAR LED

## LEDVANCE FLOODLIGHT LED

Luminaire efficacy: up to 100 lm/W

Color temperature: 3,000 K

Beam angle: 100°

Type of protection: IP65

Impact resistance: IK07

Black or white polycarbonate housing, tempered glass cover, carbon steel bracket, aluminum heat sink

Lifetime (L70/B50): up to 30,000 h



LEDVANCE FLOODLIGHT LED



## LEDVANCE HIGH BAY LED

Product features

Luminaire efficacy: 110 lm/W

5 years guarantee

Color temperature: 4,000 K

Type of protection: IP65

Luminous flux: up to 22,000 lm

Lifetime (L70/B50): up to 50,000 h

Available with beam angle: 70°, 90°

Certificates: CE, CB, TUEV SUED



LEDVANCE DOWNLIGHT LED

# OSRAM LEDVANCE





# SITECO PRODUCTS

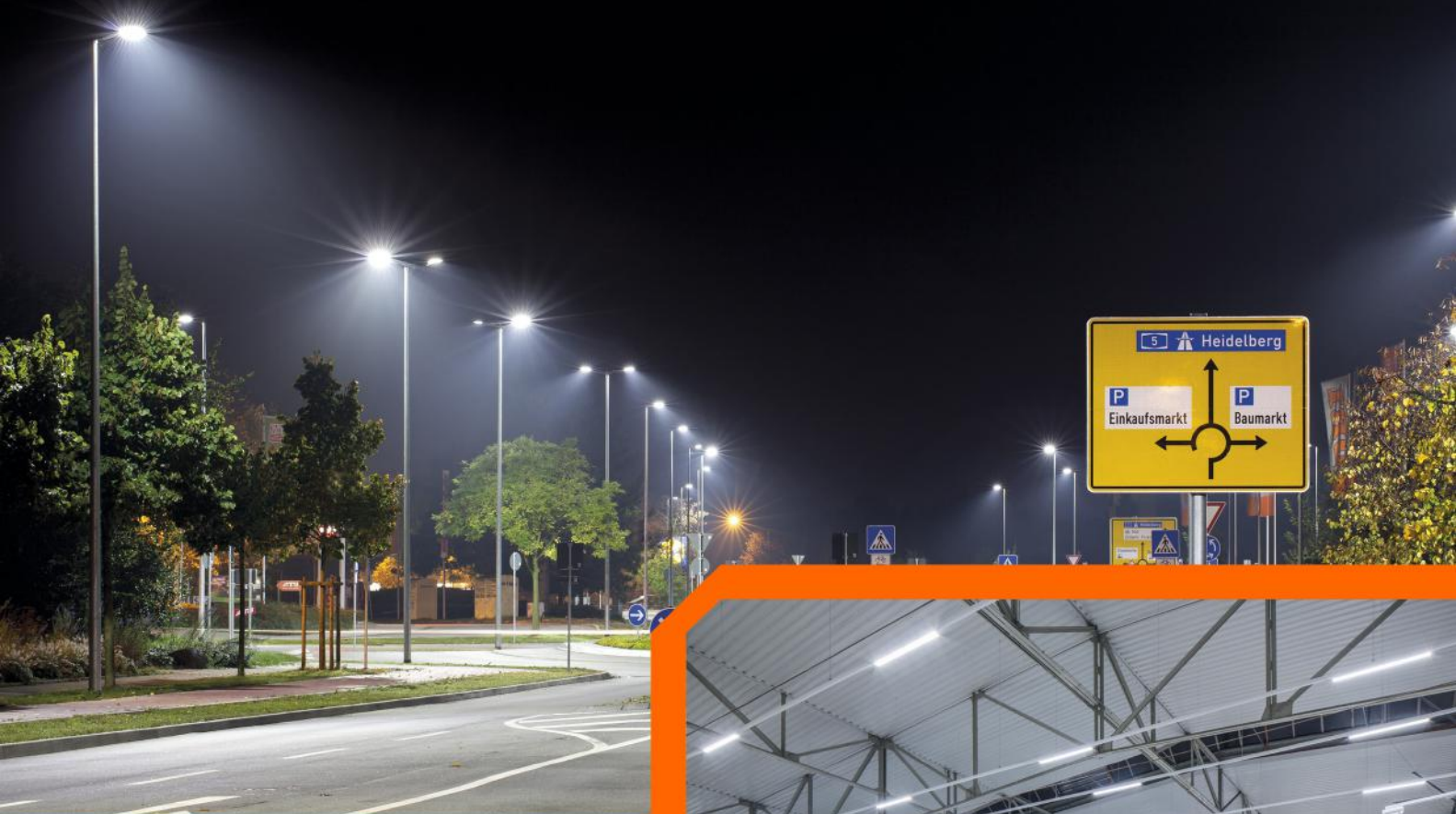

## SITECO LED products:

Siteco is one of the leading manufacturers for technical indoor and outdoor lighting. With their longstanding expertise Siteco has a decisive effect on modern lighting technology and stands for technologically premium LED lighting solutions and project solutions expertise around the globe.

- The tradition of light
- Non-stop innovation
- Experience light
- When it comes to important innovations in the lighting sector, Siteco has always been at the forefront
- Indoor and outdoor lighting solutions

  
**siteco**



# SITECO STREETLIGHT PRODUCTS



## SITECO STREETLIGHT TV 20 LED

*Rough ambient conditions as found in tunnels, underpasses and challenging industrial environments demand especially robust and resistant luminaires.*

*With the specification of maximum quality materials and components, the Siteco anti-vandal luminaire is able to ideally fulfill such requirements.*



## SITECO STREETLIGHT TV 20 LED



## SITECO STREETLIGHT Floodlight 20 max LED

*Floodlight 20 maxi LED with greater light comfort, improved planning and selection options has been specifically developed for large area and sports lighting.*

*The maxi is tailor-made for each specific application taking into account, lifetime luminous flux and ambient temperatures.*



## SITECO STREETLIGHT Floodlight 20 max LED

## SITECO STREETLIGHT SiCOMPACT® R1 MINI

*Projector is ideal for short projector-reflector distances compact diecast aluminium housing with narrow distribution optics including pressure equalisation port preventing condensation in housing. High light output ratio with compact design*



## SITECO STREETLIGHT SiCOMPACT® R1 MINI



**SITECO STREETLIGHT DL**  
*A road luminaire with outstanding design, high-efficiency LED technology and excellent optics Provides lighting with max visual comfort and a best feel-good factor, ideal for the standard-compliant illumination of residential and collection roads, atmospheric lighting of parks and town squares.*

## SITECO STREETLIGHT DL® 20 LED



**siteco**



# LED FLIAMENTS BULBS (VISIONAL)



## LED Filaments Bulbs VISIONAL:

- Low energy consumption, up to 80% energy saving
- Classic design
- High energy efficiency
- High quality materials
- Instant full light
- Low heat emission
- Long lifetime
- Maximum efficiency



**VISIONAL** <sup>®</sup> **LED**  
PREMIUM



# LED FLIAMENTS BULBS (VISIONAL)



Best choice for unique and antique interior



Preferred for classic design



Kvēldiega spuldze (1910)

LED spuldze (2016)



60W

6W

SAVE UP TO 90%



Model Modelis Модель	Power (Wattage) Jauda Мощность	LED type LED tips LED тип	Lumen output range Gaismas plūsma Световой поток	Color temperature Krāsū temperatūra Температура цвета	Beam angle Spīdēšanas leņķis Угол рассеивания	Lifetime Kalpošanas ilgums Срок службы	Nominal voltage Spriegums Напряжение	Length Izmēri Размеры
E27 (A60)	8W	SAMSUNG	650 Lm	3000K	330°	50 000h.	220-240V AC	60x105 mm
E27 (A60)	10W	SAMSUNG	810 Lm	3000K	330°	50 000h.	220-240V AC	60x105 mm
E27 (A60)	12W	SAMSUNG	1055 Lm	3000K	330°	50 000h.	220-240V AC	60x105 mm
E14 (T37)	2W	SAMSUNG	250 Lm	3000K	330°	50 000h.	220-240V AC	37x99 mm
E14 (T37)	4W	SAMSUNG	470 Lm	3000K	330°	50 000h.	220-240V AC	37x99 mm
E14 (T37)	6W	SAMSUNG	520 Lm	3000K	330°	50 000h.	220-240V AC	37x99 mm
E14 (P45)	2W	SAMSUNG	250 Lm	3000K	330°	50 000h.	220-240V AC	45x82 mm
E14 (P45)	4W	SAMSUNG	470 Lm	3000K	330°	50 000h.	220-240V AC	45x82 mm
E27 (G45)	4W	SAMSUNG	470 Lm	3000K	330°	50 000h.	220-240V AC	45x82 mm



**VISIONAL** <sup>®</sup> **LED**  
PREMIUM



# LED BULBS VISIONAL EXCLUSIVE EDITION

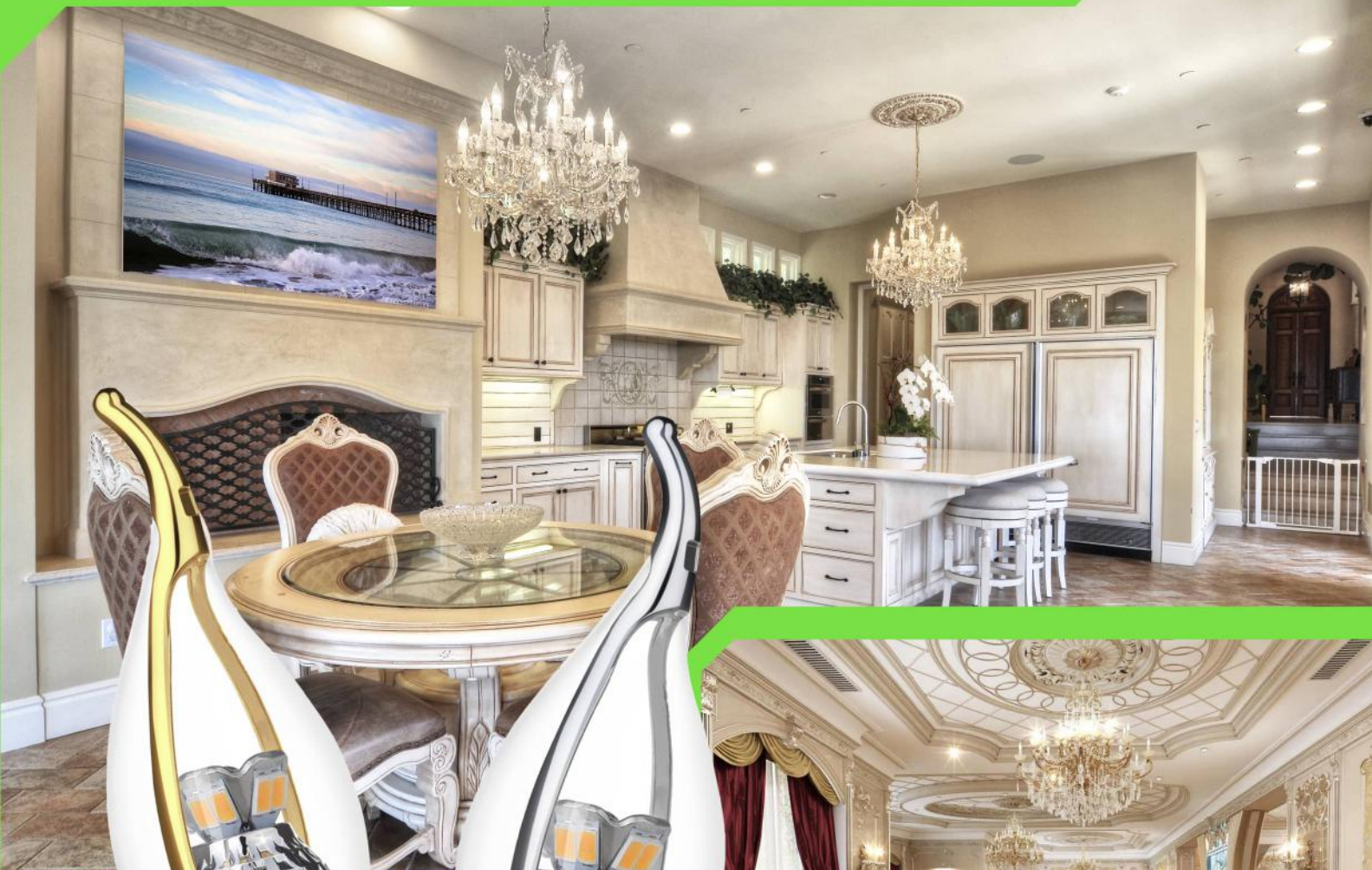

## LED bulbs VISIONAL EXCLUSIVE:

- Stylish gorgeous design
- Energy efficient – up to 80% energy savings
- Proven reliability and durability
- Instant light
- Low heat emission
- High quality materials
- Warm light with maximum efficiency

**3** YEARS  
FACTORY  
WARRANTY



**VISIONAL** **LED**  
PREMIUM



# LED BULBS VISONAL EXCLUSIVE EDITION



3000K  
Warm  
White

RA 80



50-60  
Hz



Model Modelis Модель	Lamp Base Lampas bāze База лампочки	Power (Wattage) Jauda Мощность	Lumen output range Gaismas plūsma Световой поток	LED type LED tips LED тип	Beam angle Spīdēšanas leņķis Угол рассеивания	Nominal voltage Spriegums Напряжение	Lifetime Kalpošanas ilgums Срок службы
VISIONAL EXCLUSIVE EDITION silver	E14	3,5 W	350 Lm	Samsung 3014	270°	220-240V	50000 h.
VISIONAL EXCLUSIVE EDITION golden	E14	3,5W	350 Lm	Samsung 3014	270°	220-240V	50000 h.
VISIONAL EXCLUSIVE EDITION silver	E14	3,5 W	350 Lm	Samsung 3014	270°	220-240V	50000 h.
VISIONAL EXCLUSIVE EDITION golden	E14	3,5W	350 Lm	Samsung 3014	270°	220-240V	50000 h.
VISIONAL EXCLUSIVE EDITION silver	E14	4,5 W	450 Lm	Samsung 3014	270°	220-240V	50000 h.
VISIONAL EXCLUSIVE EDITION golden	E14	4,5W	450 Lm	Samsung 3014	270°	220-240V	50000 h.
VISIONAL EXCLUSIVE CRYSTAL	E14	5 W	400 Lm	Samsung 3014	360°	220-240V	50000 h.

**VISIONAL** **LED**  
PREMIUM



# LED BULBS (VISIONAL 360)



LED Bulbs VISIONAL PREMIUM for home and business

- Low energy consumption, up to 80% energy saving
- Wider illumination angle
- Improved lamp housing
- Instant full light
- Low heat emission
- Long lifetime
- Brighter than most of the known brands
- Warm light with maximum efficiency

**3** YEARS  
FACTORY  
WARRANTY

LED SERIES | 360°

**VISIONAL** LED PREMIUM



# LED BULBS (VISIONAL 360)



3000K  
Warm  
White

RA 80



50-60  
Hz



Lamp Base Lampas bāze База лампочки	Power (Wattage) Jauda Мощность	Lumen output range Gaismas plūsma Световой поток	LED type LED tips LED тип	Beam angle Spīdēšanas leņķis Угол рассеивания	Nominal voltage Spriegums Напряжение	Lifetime Kalpošanas ilgums Срок службы	Dimension Размеры Izmēri
E27 (G45)	5W	500 Lm	Samsung	300°	85-265V	50000 h	Ø45x75 mm
E27	5W	500 Lm	Samsung	300°	85-265V	50000 h	Ø60x110mm
E27 (candle)	6W	570 Lm	Samsung	270°	85-265V	50000 h	Ø34x110 mm
E27	7W	700 Lm	Samsung	300°	85-265V	50000 h	Ø60x110 mm
E27	10W	1000 Lm	Samsung	300°	85-265V	50000 h	Ø60x110 mm
E27 (R63)	10W	1000 Lm	Samsung	200°	85-265V	50000 h	Ø63x110 mm
E27	12W	1200 Lm	Samsung	300°	85-265V	50000 h	Ø60x110 mm
E14	4W	370 Lm	Samsung	270°	85-265V	50000 h	Ø34x115 mm
E14(P45)	5W	500 Lm	Samsung	300°	85-265V	50000 h	Ø50x87 mm
E14	6W	540 Lm	Samsung	270°	85-265V	50000 h	Ø49x59 mm
E14 (R50)	6W	600 Lm	Samsung	300°	85-265V	50000 h	Ø50x87 mm
GU10	3W	300 Lm	Samsung	120°	85-265V	50000 h	Ø49x59 mm
GU10	5W	470 Lm	Samsung	120°	85-265V	50000 h	Ø49x59 mm
GU10	7W	650 Lm	Samsung (CBO)	90°	85-265V	50000 h	Ø49x59 mm
GU10	7W	650 Lm	Samsung	120°	85-265V	50000 h	Ø49x59 mm
GU10	8W	695 Lm	Samsung	90°	85-265V	50000 h	Ø49x59 mm
G5.3/MR16	3W	300 Lm	Samsung	120°	85-265V	50000 h	Ø49x59 mm
G5.3/MR16	5W	470 Lm	Samsung	120°	12V AC/DC	50000 h	Ø49x59 mm



# VISIONAL LED PREMIUM



# LED BULBS (VISIONAL)



## LED Bulbs VISIONAL:

- Low energy consumption, up to 80% energy saving
- Quick, simple and safe replacement
- Dimmable bulbs are available
- Wide range of products
- High quality materials
- Instant full light
- Low heat emission
- Long lifetime
- Maximum efficiency



**VISIONAL** **LED**  
PREMIUM



# LED BULBS (VISIONAL 360)



5W-12W



RGB

3000K

dimmable



4W-6W



3W-8W



Model Modelis Модель	Power (Wattage) Jauda Мощность	LED type LED tips LED тип	Lumen output range Gaismas plasma Световой поток	Color temperature Krāsu temperatura Температура цвета	Beam angle Spīdēšanas leņķis Угол рассеивания	Lifetime Kalpošanas ilgums Срок службы	Nominal voltage Spriegums Напряжение
E27 360° MCOB	7W	MCOB	840 Lm	3000K-6000K	360°	50000 h	200-240V AC
E27 (Filament)	6W	Sharp	600 Lm	2700K	360°	50000 h	200-240V AC
E14 (Filament)	4W	Sharp	400 Lm	2700K	360°	50000 h	200-240V AC
AR111-GU53	15W	Epistars	1200 Lm	3000K-6000K	28°/36°/45°	50000 h	DC 12V
AR111	15W	Samsung	1300 Lm	3000K-6000K	28°/36°/45°	50000 h	DC 12V
R7S 78mm	5W	2835 Samsung	500 Lm	3000K-6000K	360°	50000 h	200-240V AC
R7S 118mm	10W	2835 Samsung	1000 Lm	3000K-6000K	360°	50000 h	200-240V AC
R7S 135mm	12W	2835 Samsung	1200 Lm	3000K-6000K	360°	50000 h	200-240V AC
R7S 189mm	15W	2835 Samsung	1500 Lm	3000K-6000K	360°	50000 h	200-240V AC



3W-7W

# VISIONAL<sup>®</sup> LED PREMIUM



# FLEXIBLE LED STRIPS VISIONAL



## Flexible LED strips VISIONAL:

- Create unique and gorgeous lighting design
- Flexible modern design
- Easy to install Simple and fast connection
- High quality materials
- High output – High efficiency
- Multiple visual effects, wide range of colors and shades
- Available in 12V and 220V with different color range (WW / NW / CW / R/G/B/)
- Proven reliability and durability



**VISIONAL** **LED**  
PREMIUM



# FLEXIBLE LED STRIPS VISIONAL

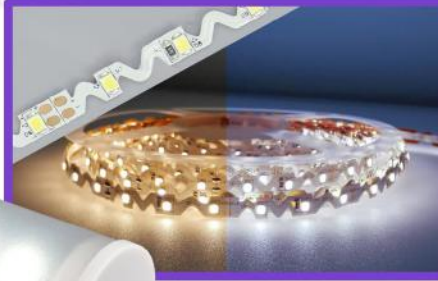

20W - 60W



80W - 100W

## LED modules

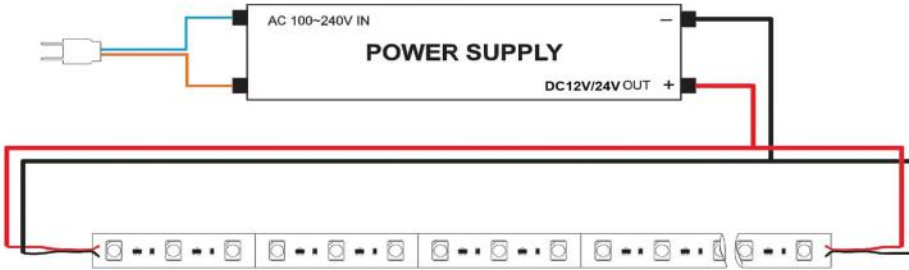

120W - 150W

Model	Modelis	Модель	Color Krāsa Цвет	LED per meter LED pēc metrā LED за метр	Nominal voltage Spriegums Напряж.	Beam angle Spīdēšanas leņķis Угол рас.	Power (Wattage) Jauda Мощность	Lumen output range Gaismas plūsma Световой	Meters per roll Metri pēc ruļļa Метров за рулон
LED strip SMD 3528 - 4.8W HIGH POWER (color of base - white)			CW /NW/ WW/ R/G/B	60 led/m	12V DC	130°	4,8 W/m	420 lumen	5 m
LED strip SMD 3528 - 9.6 W HIGH POWER (color of base - white)			CW /NW/ WW/ R/G/B	120 led/m	12V DC	130°	9,6 W/m	840 lumen	5 m
LED strip SMD 2835 - 14.4 W HIGH POWER (color of base - white)			CW /NW/ WW/ R/G/B	60 led/m	12V DC	130°	14,4 W/m	1440 lumen	5 m
LED strip SMD 2835 - 28.8 W HIGH POWER (color of base - white)			CW /NW/ WW/ R/G/B	120 led/m	12V DC	130°	28,8 W/m	2880 lumen	5 m
LED strip SMD 5050 - 7.2W HIGH POWER (color of base - white)			CW /NW/ WW/ R/G/B	30 led/m	12V DC	130°	7,2 W/m	540 lumen	5 m
LED strip SMD 5050 - 14.4W HIGH POWER (color of base - white)			CW /NW/ WW/ R/G/B	60 led/m	12V DC	130°	14,4 W/m	1080 lumen	5 m
LED strip SMD 3014 - 5.8 W HIGH POWER (color of base - white)			CW /NW/ WW/ R/G/B	60 led/m	12V DC	130°	5,8 W/m	840 lumen	5 m
LED strip SMD 3014 - 11.6 W HIGH POWER (color of base - white)			CW /NW/ WW/ R/G/B	120 led/m	12V DC	130°	11,6 W/m	1680 lumen	5 m
LED strip SMD 3014 - 23.2 W HIGH POWER (color of base - white)			CW /NW/ WW/ R/G/B	240 led/m	12V DC	130°	23,2 W/m	3360 lumen	5 m
DOUBLE WATERPROF - IP68 - LED strip SMD 5050 - 14.4W			CW /NW/ WW/ R/G/B	60 led/m	12V DC	130°	14,4 W/m	1450 lumen	5 m
SIDE VIEW LED strip 3014 - 5.8W HIGH POWER			CW /NW/ WW/ R/G/B	60 led/m	12V DC	130°	5,8 W/m	840 lumen	5 m
LED strip SMD 5730 - 19.2W HIGH POWER (color of base - white)			CW /NW/ WW/ R/G/B	60 led/m	12V DC	130°	19,2 W/m	3300 lumen	5 m
LED bendable strip 2835 - 14.4W (color of base - white)			CW /NW/ WW/ R/G/B	60 led/m	12V DC	130°	14,4 W/m	1440 lumen	5 m



180W - 200W

SAMSUNG

VISIONAL<sup>®</sup> LED PREMIUM



# POWER SUPPLY UNITS / ACCESSORIES

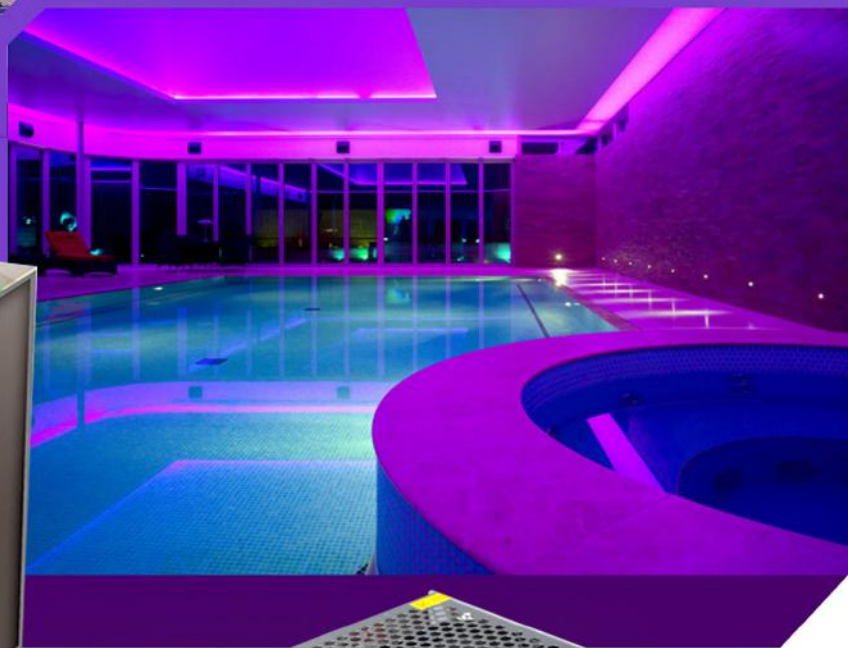

## Power supply unit / accessories:

- Create unique and gorgeous lighting design
- Modern design
- Simple and fast connection
- High quality materials
- Control lighting
- Multiple visual effects, wide range of colors and shades
- Proven reliability and durability

**VISIONAL** **LED**  
PREMIUM



# POWER SUPPLY UNITS / ACCESSORIES



IP20



IP44



IP67



Wireless Device



Wi-Fi Controller





# LED DISPLAYS / LED BLACKBOARDS

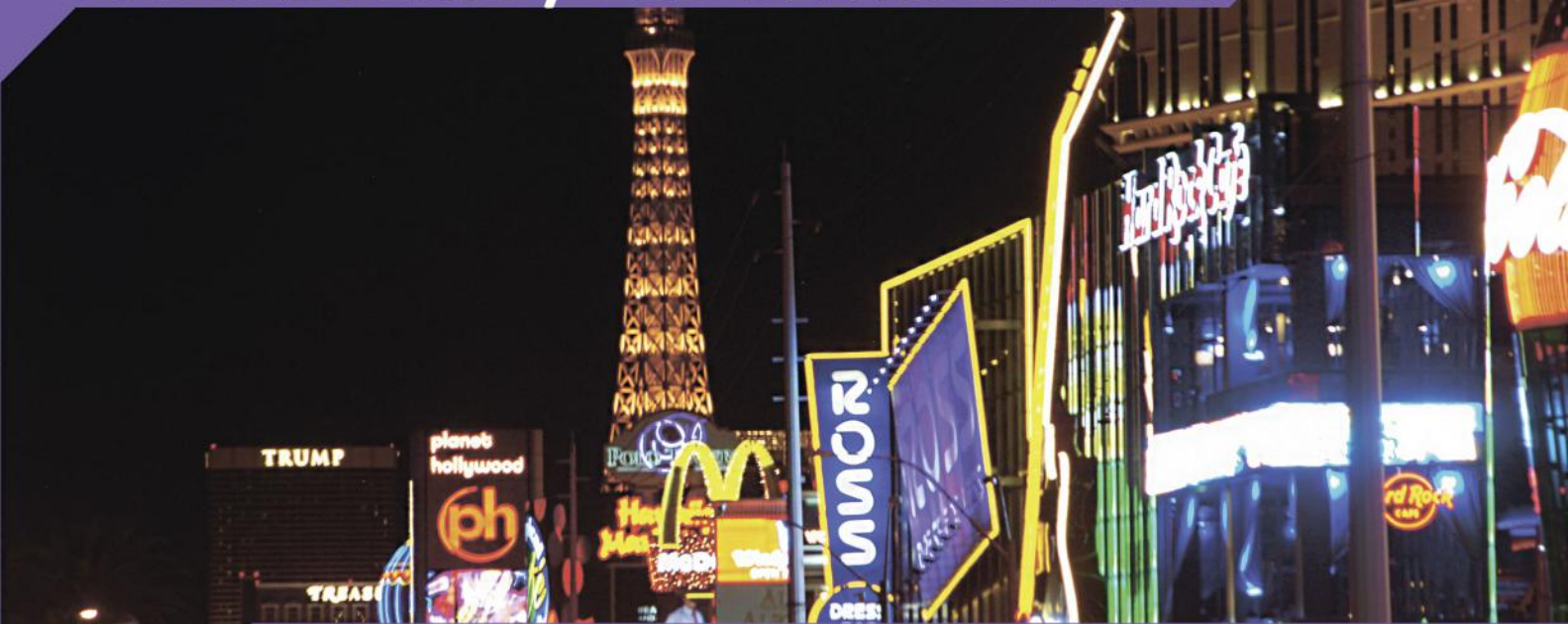

## LED Displays and LED Blackboards:

- Intelligent solutions that help to showcase a message and capture attention
- Customize your message and Capture Attention
- Functional, bright and modern
- Easy to install
- Long lifetime - up to 100 000 hours
- High quality materials
- Long-term use
- Energy Efficient



**VISIONAL** **LED**  
PREMIUM



# LED DISPLAYS / LED BLACKBOARDS



**VISIONAL** **LED**<sup>®</sup>  
PREMIUM



# OTHER LED PRODUCTS



## LED Products VISIONAL

- Proven reliability and durability
- Energy efficient
- Bright and instant light
- High quality materials

**VISIONAL** **LED**  
PREMIUM



# OTHER LED PRODUCTS



LED SAUNA LIGHTS





# VISIONAL SMART BALANCE SCOOTER



## SMART BALANCE SCOOTER VISIONAL:

- Its the hottest new mode of transportation
- Self balancing scooters are made with premium materials, chips and sensors, allowing you to travel on all terrains with ease of use.
- They incorporate the aerospace philosophy of control theory, software algorithms, gyroscope systems and balance control.
- Its great for kids and adults alike.



# VISIONAL<sup>®</sup>

SMART BALANCE SCOOTER

NEWEST GENERATION



# VISIONAL SMART BALANCE SCOOTER



**SAMSUNG**

BATTERY



6,5  
inches



8-10  
inches



DISTANCE  
UP TO  
**30** KM

**20**  
MAX SPEED KM/H



15  
inches

## ADVANTAGES

- SAFETY CERTIFICATE SGS
- POWER OF BATTERY - 42V
- SUPER BRIGHT LED LIGHTS
- ORIGINAL SAMSUNG BATTERY
- ANTI-FALLING ALARM SYSTEM
- TIME OF USING - UP TO 3 HOURS
- NEWEST ELECTRONIC COMPONENTS
- LIFETIME AFTER WARRANTY SERVICE
- NEWEST POWERFUL ENGINE 350W X 2
- LIMITED FACTORY WARRANTY 2 YEARS

**Bluetooth** + REMOTE CONTROL + SPEAKER



MINI

# VISIONAL®

## SMART BALANCE SCOOTER

NEWEST GENERATION



# OUR PROJECTS/ MŪSU DARBI

## Radio SWH



## Industrial complex IZOTERMS



## Freeport of Riga



## STOCKMANN





# OUR PROJECTS / MŪSU DARBI

Privātmāju teritorijas un fasāžu apgaismojums



“RIX” - muitas noliktava



Automazgātava “PAPRIKA”

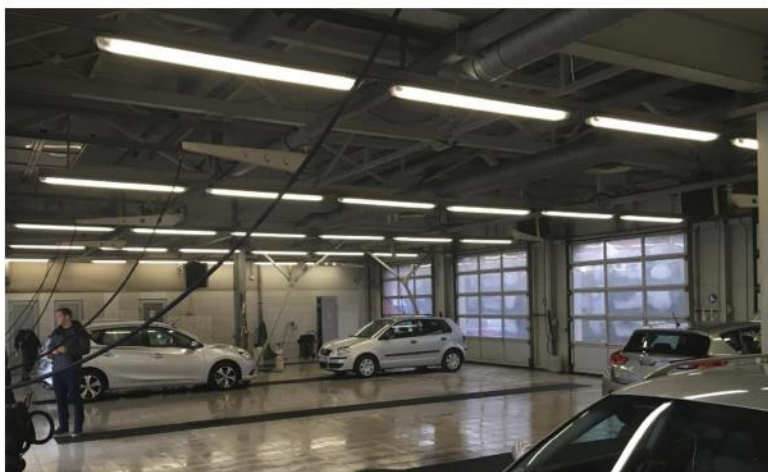

Automazgātava "CarWash ERHLE"



Latio / Parex bankas bijusī ēka

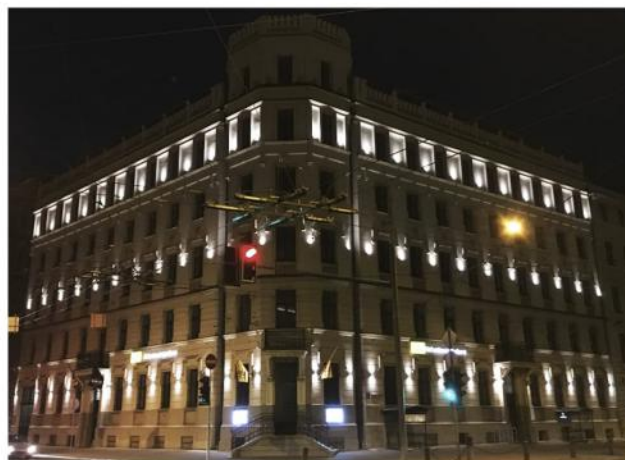

Dzīvojamo māju komplekss "Sky-garden" Jūrmala



Autoserviss “LATAKKO”



"TUF" Autocentrs

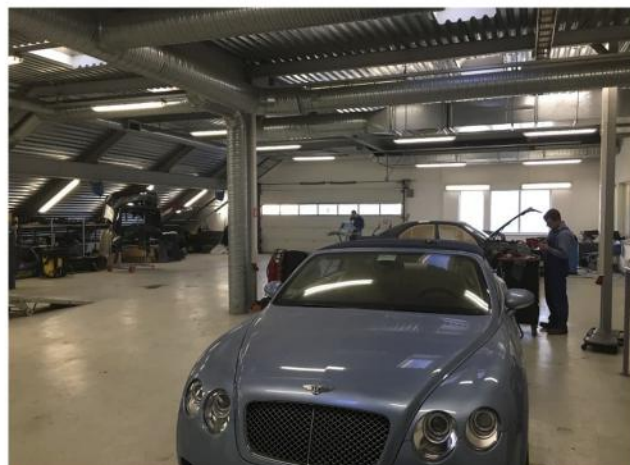



# OUR PROJECTS / MŪSU DARBI

"Gan bei" Restorāns

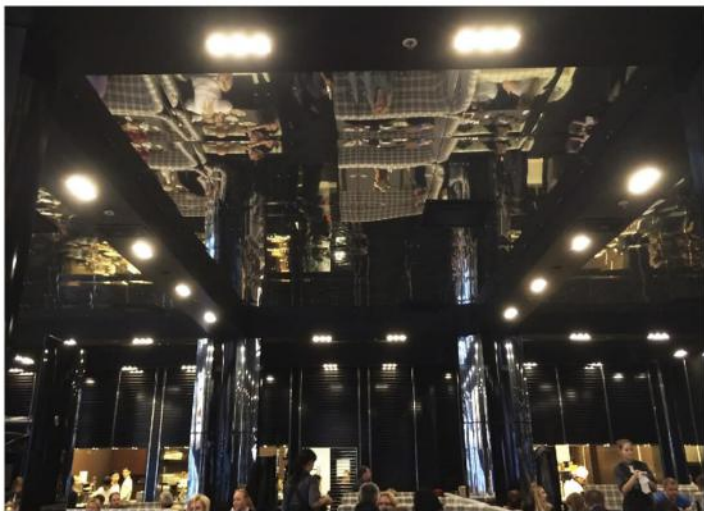

Picērija "Can Can" sia Eiropica



Restorāns "ARMENIA"



Restorāns "Illu Zion"

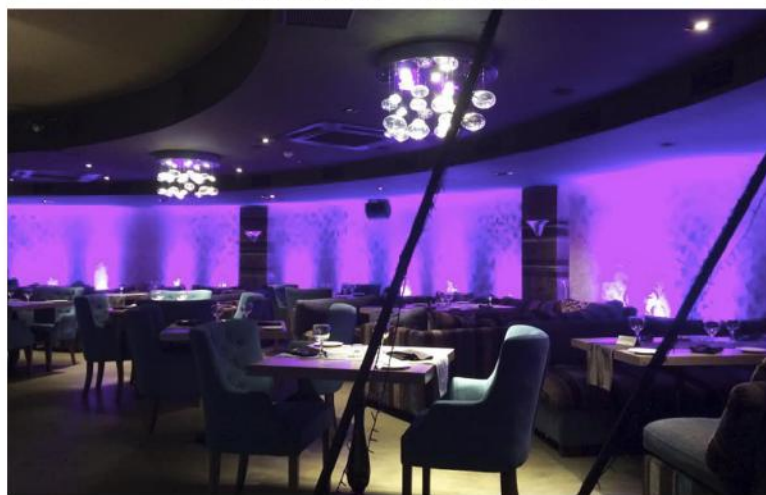

"TYTAN" Fitnesa centrs

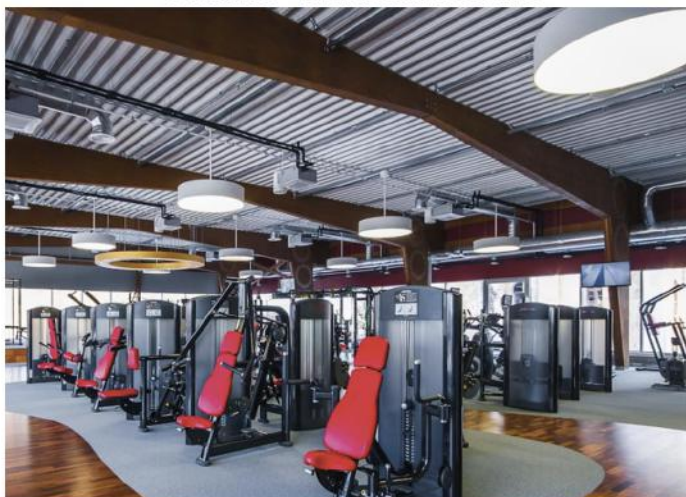

"GLOBAL FITNESS" Fitnesa centrs

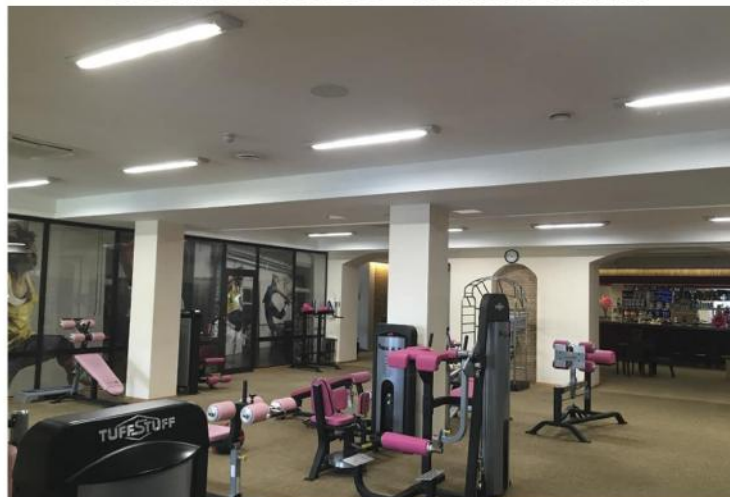

"ATLETIKA" Fitnesa centrs



"SPORTIMA" Fitnesa centrs





# OUR PROJECTS / MŪSU DARBI

**"Tez tour" - Galvenais Birojs Rīgā**



**Izdevniecība "DIENA"**

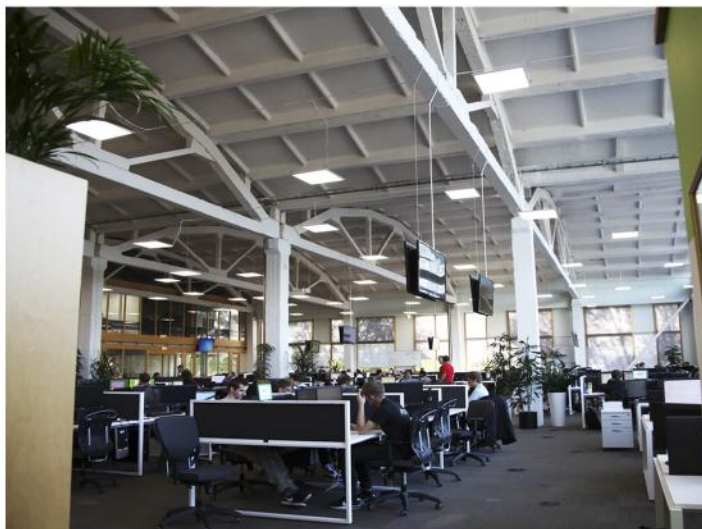

**"LATAKKO" Galvenais ofiss**

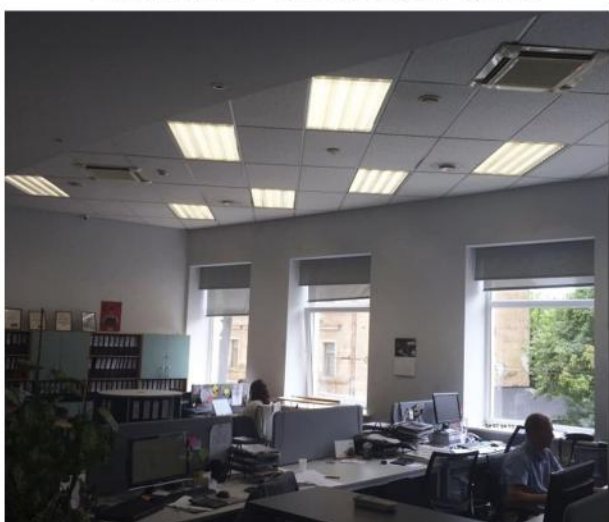

**Iljasa Vahitova zobārstniecība "ELSIA"**



**Degvielas uzpildes stacija "TOTALS"**



**"OLYMPIC" Spēļu zāle**

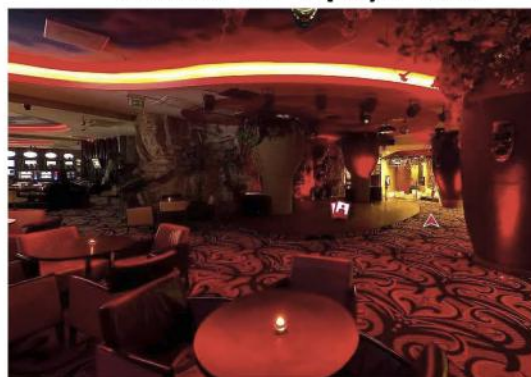

**LED 3D daudzkrāsu mājas griestu apgaismojums**



**Privātmāju Ziemassvētku apgaismojums**





# EUROLED.LV

LED ENERGY-SAVING LIGHTING  
FOR HOME AND BUSINESS



**We are looking forward to long-term cooperation!**

## **Contact us:**

**129, A. Chaka str., Riga, Latvia  
148, Kalnciema str., Riga, Latvia  
+371 28 888 824  
info@euroled.lv  
www.euroled.lv**