

COPYRIGHT © Hangzhou EZVIZ Software Co., Ltd.. ALL RIGHTS RESERVED.

Any and all information, including, among others, wordings, pictures, graphs are the properties of Hangzhou EZVIZ Software Co., Ltd. (hereinafter referred to as “EZVIZ”). This user manual (hereinafter referred to as “the Manual”) cannot be reproduced, changed, translated, or distributed, partially or wholly, by any means, without the prior written permission of EZVIZ. Unless otherwise stipulated, EZVIZ does not make any warranties, guarantees or representations, express or implied, regarding to the Manual.

### **About this Manual**

The Manual includes instructions for using and managing the product. Pictures, charts, images and all other information hereinafter are for description and explanation only. The information contained in the Manual is subject to change, without notice, due to firmware updates or other reasons. Please find the latest version in the EZVIZ™ website (<http://www.ezvizlife.com>).

### **Revision Record**

New release – January, 2019

### **Trademarks Acknowledgement**

EZVIZ™, ™, and other EZVIZ's trademarks and logos are the properties of EZVIZ in various jurisdictions. Other trademarks and logos mentioned below are the properties of their respective owners.

### **Legal Disclaimer**

TO THE MAXIMUM EXTENT PERMITTED BY APPLICABLE LAW, THE PRODUCT DESCRIBED, WITH ITS HARDWARE, SOFTWARE AND FIRMWARE, IS PROVIDED “AS IS”, WITH ALL FAULTS AND ERRORS, AND EZVIZ MAKES NO WARRANTIES, EXPRESS OR IMPLIED, INCLUDING WITHOUT LIMITATION, MERCHANTABILITY, SATISFACTORY QUALITY, FITNESS FOR A PARTICULAR PURPOSE, AND NON-INFRINGEMENT OF THIRD PARTY. IN NO EVENT WILL EZVIZ, ITS DIRECTORS, OFFICERS, EMPLOYEES, OR AGENTS BE LIABLE TO YOU FOR ANY SPECIAL, CONSEQUENTIAL, INCIDENTAL, OR INDIRECT DAMAGES, INCLUDING, AMONG OTHERS, DAMAGES FOR LOSS OF BUSINESS PROFITS, BUSINESS INTERRUPTION, OR LOSS OF DATA OR DOCUMENTATION, IN CONNECTION WITH THE USE OF THIS PRODUCT, EVEN IF EZVIZ

HAS BEEN ADVISED OF THE POSSIBILITY OF SUCH DAMAGES. TO THE MAXIMUM EXTENT PERMITTED BY APPLICABLE LAW, IN NO EVENT SHALL EZVIZ'S TOTAL LIABILITY FOR ALL DAMAGES EXCEED THE ORIGINAL PURCHASE PRICE OF THE PRODUCT.

EZVIZ DOES NOT UNDERTAKE ANY LIABILITY FOR PERSONAL INJURY OR PROPERTY DAMAGE AS THE RESULT OF PRODUCT INTERRUPTION OR SERVICE TERMINATION CAUSED BY: A) IMPROPER INSTALLATION OR USAGE OTHER THAN AS REQUESTED; B) THE PROTECTION OF NATIONAL OR PUBLIC INTERESTS; C) FORCE MAJEURE; D) YOURSELF OR THE THIRD PARTY, INCLUDING WITHOUT LIMITATION, USING ANY THIRD PARTY'S PRODUCTS, SOFTWARE, APPLICATIONS, AND AMONG OTHERS.

REGARDING TO THE PRODUCT WITH INTERNET ACCESS, THE USE OF PRODUCT SHALL BE WHOLLY AT YOUR OWN RISKS. EZVIZ SHALL NOT TAKE ANY RESPONSIBILITIES FOR ABNORMAL OPERATION, PRIVACY LEAKAGE OR OTHER DAMAGES RESULTING FROM CYBER ATTACK, HACKER ATTACK, VIRUS INSPECTION, OR OTHER INTERNET SECURITY RISKS; HOWEVER, EZVIZ WILL PROVIDE TIMELY TECHNICAL SUPPORT IF REQUIRED. SURVEILLANCE LAWS AND DATA PROTECTION LAWS VARY BY JURISDICTION. PLEASE CHECK ALL RELEVANT LAWS IN YOUR JURISDICTION BEFORE USING THIS PRODUCT IN ORDER TO ENSURE THAT YOUR USE CONFORMS TO THE APPLICABLE LAW. EZVIZ SHALL NOT BE LIABLE IN THE EVENT THAT THIS PRODUCT IS USED WITH ILLEGITIMATE PURPOSES.

IN THE EVENT OF ANY CONFLICTS BETWEEN THE ABOVE AND THE APPLICABLE LAW, THE LATTER PREVAILS.

# Operations

## Step 1 Power-on

Connect the camera to power outlet with the power adapter, as shown below.

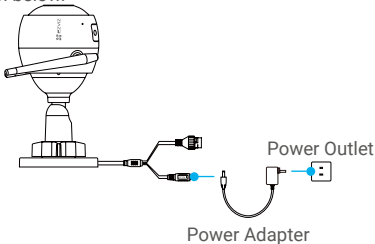

## Step 2 Camera Setup

### 1. Create a user account

- Connect your mobile phone to Wi-Fi.
- Download and install the EZVIZ app by searching “EZVIZ” in App Store or Google Play™.
- Launch the app and register an EZVIZ user account following the start-up wizard.

### 2. Add a camera to EZVIZ

- Log in the EZVIZ app.
- From the EZVIZ app Home screen, tap “+” on the upper-right hand corner to go to the scan QR code interface.

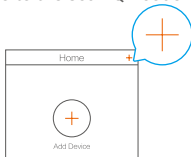

- Scan the QR code on the body of the camera.

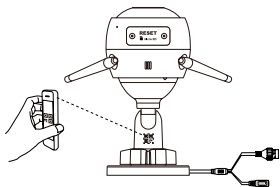

- Follow the EZVIZ app wizard to finish Wi-Fi configuration.

You can also select wired connection.

- connect the camera to a router with a network cable.
- add the camera to EZVIZ app by scanning its QR code.

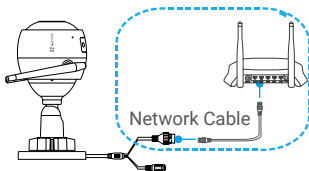

- i** • Hold the RESET button for 5 seconds when adding cameras or Wi-Fi connection failed.
- Please make sure your phone is connected to the 2.4GHz Wi-Fi from the router for Wi-Fi configuration.

### Step 3 Camera Installation

You can install the camera on the wall or ceiling.

- i** • Make sure the wall is strong enough to withstand three times the weight of the camera.
- Recommended installation height: 3m (10 ft).

#### 1 Install the Camera

- Place drill template onto the surface you have chosen to mount the camera.
- **(For the cement wall/ceiling only)** Drill screw holes according to the template, and insert three anchors.
- Use three metal screws to fix the camera base according to the template.

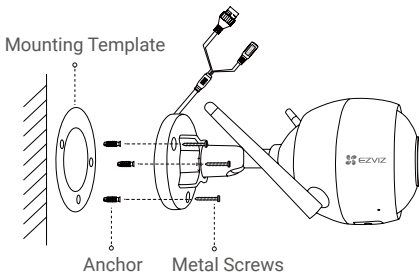

#### 2 Adjust the Surveillance Angle

- Loosen the adjusting screw.
- Adjust the surveillance angle as your desired place.
- Tighten the adjusting screw when you have your camera in the position you want.

- i** Make sure the microSD card slot is facing downward.

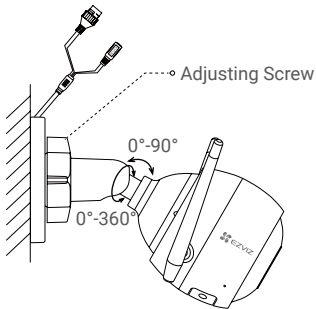

### 3 Install the waterproof kit (Optional)

**i** If the camera is installed outdoors or in the humid environment, please use the waterproof kit.

- Insert the gasket to the network port of the camera.



- Pass the A side of the network cable through the nut, the gasket and the endcap.

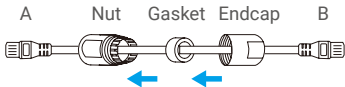

- Tighten up the nut and the endcap.



- Insert the A side into the network port of the camera and tighten up the nut.



- Connect the B side with the LAN port of the router.



## Appendix

### Box Contents

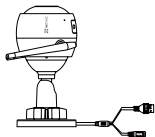

Internet Camera x1



Power Adapter x1



Regulatory Information x1



Mounting Template  
x1



Screw Kit  
x1

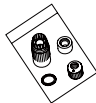

Waterproof  
Kit x1



Quick Start Guide  
x1

## Basics

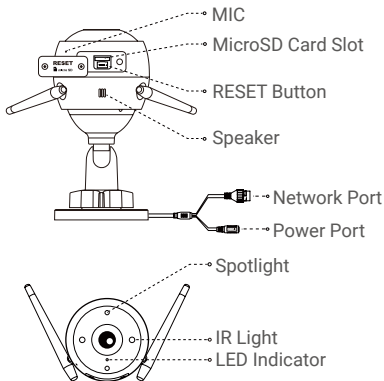

Name	Description
LED Indicator	<ul style="list-style-type: none"><li>• Solid Red: Camera is starting up.</li><li>• Slow-Flashing Red: Wi-Fi connection has failed.</li><li>• Fast-Flashing Red: Camera exception (e.g. microSD card error).</li><li>• Solid Blue: Video is being viewed or played back in EZVIZ App.</li><li>• Fast-Flashing Blue: Camera is ready for the Wi-Fi connection.</li><li>• Slow-Flashing Blue: Camera is running properly.</li></ul>
MicroSD Card	It should be purchased separately. After inserting the microSD card, initialize it in the EZVIZ app, and then video files can be stored in the SD card.
RESET Button	Hold the RESET button for 5 seconds when the camera is running. The camera restarts, and resets all parameters to default.



## Troubleshooting

- Q:** “The device is offline.” or “The device is not registered.” prompts when adding the camera by EZVIZ app.
- A:** 1. Make sure the network that the camera is connected to is normal and the DHCP of router is enabled.  
2. Hold the RESET button for 5 seconds if you manually changed the network parameters.
- Q:** How to use the microSD card for local storage?
- A:** 1. Make sure there is a microSD card inserted and the camera is added to your EZVIZ account. Log in the EZVIZ app and enter the “Device Details” interface, if the “Initialize Storage Card” button appears, you need to initialize the microSD card first.  
2. The microSD card recording for the motion detection is enabled by default.
- Q:** Why does the spotlight stays turn on when the environment is bright enough?
- A:** The device may trigger a protection mechanism, which will be automatically lifted after one hour, and if you need to close it manually, tap Black/White Night Vision or Smart Night vision in the app.

## EXPOSURE TO RADIOFREQUENCY RF

The frequency bands and the nominal limits of transmitted power (radiated and/or conducted) applicable to this radio device are the following:

Band	Wi-Fi 2.4 GHz
Frequency	From 2.412 GHz to 2.472 GHz
Power transmission (EIRP)	60 mW

 For detailed information, please visit [www.ezviz.eu](http://www.ezviz.eu).